

ECHO® UNDER-DASH TRAILER BRAKE CONTROLLER INSTALLATION MANUAL

51190

TABLE OF CONTENTS

Controls & Components	page 1
Tools List	page 1
Before You Begin	page 2
Wiring	page 2
Wiring Diagram	page 3
Set Manual Control Output and Brake Light Switches	page 3
Mounting the Main Module	page 3
Initial Setup	page 4
Test Drive & Adjustment	page 7
Bench Test	page 9
Troubleshooting Guide	page 10

NOTICE

This device contains license-exempt transmitter(s) / receiver(s) that comply with Innovation, Science and Economic Development Canada's license-exempt RSS(s). Operation is subject to the following two conditions:

1. This device may not cause interference.
2. This device must accept any interference, including interference that may cause undesired operation of the device.

CONTROLS & COMPONENTS

1. Main module
2. Main module adhesive pad
3. (4) 8" Zip ties

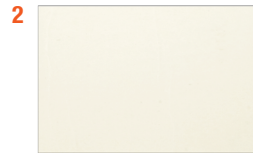

BEFORE YOU BEGIN

One or more of the following may be needed to complete the installation:

- Brake control harness, supplied with the tow vehicle (if equipped)
- CURT quick plug harness - custom connector for specific vehicles (see the CURT catalog for availability)
- CURT #51515 / #51516 - quick plug with pigtails
- CURT #51500 - universal brake control wiring kit

 **IMPORTANT:** Read and follow installation manual carefully. Failure to do so could result in damage to the brake control unit, loss of trailer brakes or poor brake performance.

Disconnect the electrical plug between the trailer and tow vehicle before testing a breakaway switch. Failure to disconnect may damage the brake control unit. Avoid mounting the brake control module near a CB radio or other RF transmitter.

 **WARNING** The main module must be mounted firmly in place. Failure to do so could lead to improper operation and / or brake failure.

 **WARNING** The main module's positive (with 30-amp circuit breaker) and ground wires must be connected directly to the tow vehicle's battery using a minimum of 10-gauge stranded wire. Connecting to existing wiring or an alternate ground may damage the vehicle's circuits, lead to failure of the brake control module, loss of trailer brakes or vehicle fire.

Note: Removal of the factory quick plug can void the warranty.

This product IS NOT compatible with Apple CarPlay or Android Auto. however it will not interfere with these features.

This product is designed to provide a Bluetooth connection, without obstructions, up to 50 ft. connection may also be limited by the Bluetooth signal of your device.

WIRING

Disconnect the tow vehicle's negative battery terminal from its battery post before beginning the installation process. Most trucks and utility vehicles are equipped with a plug from the factory that allows quick brake control installation. Check the vehicle owner's manual for plug availability, location and installation. If the mating plug supplied with the vehicle is no longer available, a CURT quick plug can be used. See the CURT catalog or visit curtmfg.com for application information. For tow vehicles not equipped with a factory brake control plug, we suggest purchasing the CURT universal brake control wiring kit #51500.

Mount the 30-amp, auto-reset circuit breaker as close to the battery as possible.

 **IMPORTANT:** When passing wires through sheet metal, always go through an existing grommet. If there is no grommet, install one or use silicone sealant to protect the wires from sharp edges.

Insert two 10-gauge wires, one white and one black, from the mounted brake control to the battery area. Using a ring terminal, connect the black wire to the 'AUX' side of the 30-amp circuit breaker. Leave the white wire to be connected later. Using a 10/12-gauge butt connector, attach the black wire from the 'AUX' side of the 30-amp circuit breaker to the brake control's black wire. Again using a 10/12-gauge butt connector, attach the white wire from the battery area to the brake control's white wire. Run a 10-gauge blue wire from the tow vehicle's trailer plug 'BRAKE' terminal to the brake control. Using a 10/12-gauge butt connector, connect this wire to the brake control's blue wire.

 **NOTICE** If the device application cannot connect to the unit due to an incorrect or missing PIN, contact CURT product support. They will need the serial number located on the label of your unit.

WIRING DIAGRAM

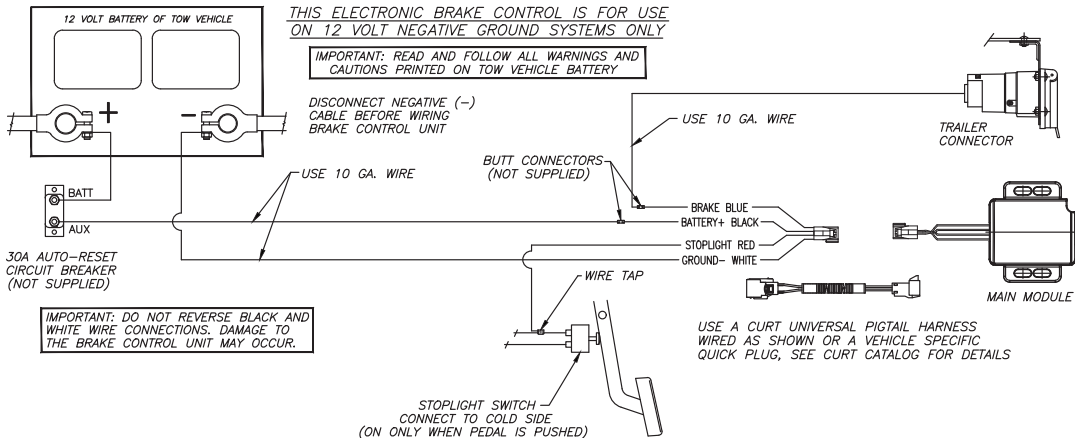

SET MANUAL CONTROL OUTPUT AND BRAKE LIGHT SWITCHES

There are two small switches located at the front of the unit, next to the port on the module. Once accessed, the switch positions can be changed using a small pointed tool.



In the illustration above, the switch on the left (#1) controls the unit's brake light activation feature. The factory default setting is the 'ON' position with the switch down. This setting activates the tow vehicle and trailer brake lights when the manual control is actuated. Moving the switch up to the 'OFF' position turns off the brake light activation feature and the brake lights are not activated when the manual control is actuated.

In the illustration above, the switch on the right (#2) controls the level of output available to the trailer brakes when using the manual control. The factory default setting is the 'ON' position with the switch down. This setting limits the manual control output to the level set using the output control. Moving this switch up to the 'OFF' position allows 100% of the output to the brakes when the manual control is actuated regardless of the output control setting.

MOUNTING THE MODULE

- Once the CURT quick connector or splice-in harness is installed, determine a suitable mounting location for the module.
 - The module must be mounted securely to a solid surface under the dash. The orientation of the module does not matter.
 - This module should be easy to access for troubleshooting. It can be installed out of sight to reduce contact with operator.



Figure 1

- See the 'Set Manual Control Output and Brake Light Switches' section in the previous section before mounting the module.
- Secure the module in place using the provided adhesive pad and zip-ties.
- Plug in the module to the pigtail harness or vehicle-specific quick plug. If harness is unavailable, hard wiring will be necessary.

DOWNLOAD THE MOBILE APPLICATION

Mobile applications are available for Apple and Android OS. They can be accessed in the App Store or Google Play by scanning the respective QR code below or searching for 'Echo® Smart Control'.

- Apple OS Requires IOS 5 or higher
- Android OS requires Android 4.3 or higher
- Bluetooth must be enabled on your device for pairing to occur
- After the app is installed, follow the prompts for setup



INITIAL SETUP FOR BLUETOOTH CONNECTION

NOTICE The vehicle needs to be running or the ignition in the 'ON' position with the vehicle in park.

NOTICE At any moment during setup, if the LED on the Echo under-dash is red, stop and refer to the 'Troubleshooting Guide'.

1. Enable Bluetooth in your mobile device settings.

NOTICE **DO NOT** pair the Echo® under-dash through your phone's Bluetooth menu. Bluetooth connection will be done through the app in step 3.

2. The Echo® under-dash is ready to pair with the mobile application.

3. Launch the app and scan for the Echo under-dash. Once the 'Echo Brake Controller' is visible, select it. You will then be prompted to enter the six-digit PIN, found under the cap of the brake controller unit or on the provided quick reference card. Once pairing is complete, the LED light will be solid blue.

4. Plug the trailer's 7-way connector into the vehicle's 7-way connector while parked on a level surface. The LED light on the Echo under-dash will flash yellow for five to eight seconds while calibration occurs. Once the device is calibrated the LED will turn solid green.

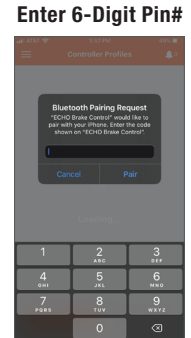
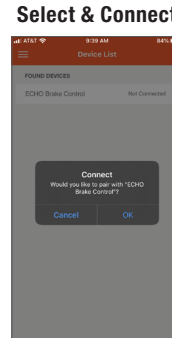
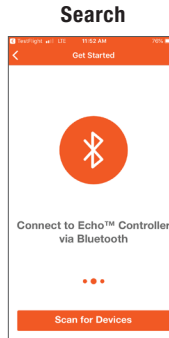

APPLICATION SETUP

After pairing with the Echo®, you will be directed to the 'Towing Profiles' screen to setup your trailer's profile. You can create and save profiles for multiple vehicles, trailers and load conditions.

Note: Setting configuration is required when trailer conditions change or the brake controller is being used for a different trailer or vehicle.

Within the 'Towing Profiles' screen, there are two different profiles menus for you to access.

1. Controller Profile

- In this menu, you can access the five most recently used settings. These settings are stored within the Echo device.
- Your active profile will display at the top of the menu (1A)

2. Application Profile

- In this menu, you can create an unlimited number of vehicle trailer profiles. These profiles are stored within the app on your phone.

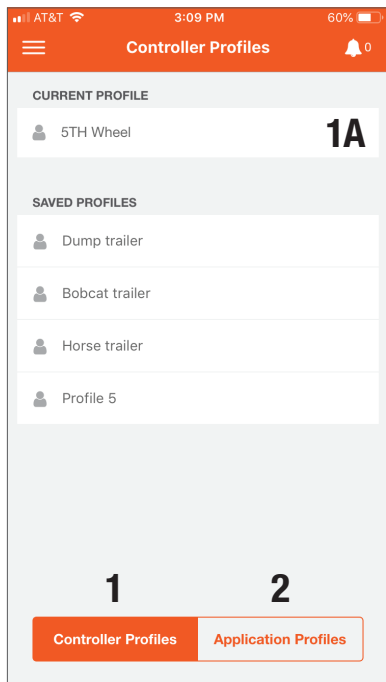

ADDING A PROFILE

1. On the 'Controller Profiles' menu, select the empty 'Current Profile' seat at the top of the menu.
2. Name the profile with descriptive information about the trailer you're towing.
3. Click 'Done' to confirm. You will then be directed to the 'Active Profiles' menu to begin set-up and adjustment.
4. You are also able to modify an existing trailer name by swiping left on the profile.
5. Repeat steps 1 – 3 for additional trailers (up to five saved on the device).

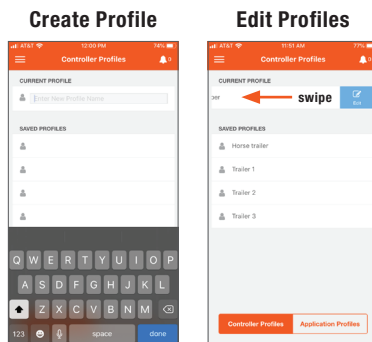

To create additional profiles, 6 or more, access the 'Application Profiles' section. This menu will allow you to create and store an unlimited number of profiles within the app. Select 'Add Profile' to begin and repeat steps 1 – 3.

ACTIVATING A PROFILE

1. Click on a profile you would like to activate.
2. Follow the screen prompt by selecting 'Ok'.
3. The profile you selected is now the active 'Current Profile'.

DELETING A PROFILE

1. In the 'Application Profiles' menu, select the profile you would like to delete.
2. Swipe left to open menu option.
3. Select 'Delete' to remove.

CONFIGURING PROFILE SETTINGS

In your 'Active Profile' screen you can adjust settings.

1. Manual Brake Activation

Activate manual braking, press and hold the orange button.

Manual brake controller activation is used in situations where a slow reduction in speed is desirable. As the manual control is activated, the Echo® begins to apply the trailer brakes. Manual output can be activated by pressing and holding the orange button in the app.

2. Brake Output Indicator

The blue ring indicates current brake output level.

The blue ring is a visual indicator of the current level of power being applied to the trailer brakes. When the vehicle's brakes are fully applied, the level of power and position of the ring is determined by your Max Output setting.

3. Max Output

The maximum level of the brake controller.

The output control establishes the max amount of power available to the trailer brakes when braking. The output should be adjusted during initial setup, when trailer load changes, when different trailers are used or when adjustment is needed for changing road or driving conditions.

4. Sensitivity Level

The sensitivity of the braking power.

The sensitivity level adjusts trailer aggressiveness when activated during braking. Sensitivity adjustment has no effect on the manual brake controller. The sensitivity can be adjusted for individual driver preference, trailer load changes or changing road conditions.

5. Screen Theme

Change from light to dark.

Under the 'Settings' menu, the option to change for day or night driving situations or application preference is available.

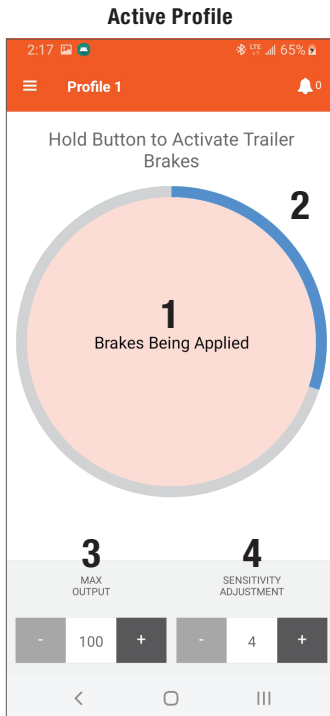

Screen Theme



TEST DRIVE & ADJUSTMENT

Both the output and sensitivity can be adjusted to achieve smooth, firm stops. Output and sensitivity adjustments should only be made while stopped, with the transmission in park or neutral, parking brake applied, foot off the brake pedal, and no manual control actuation. **Note:** Perform the adjustments in a safe environment with minimal vehicle traffic.

Starting with the output adjustment, drive forward on a dry and level paved or concrete surface. At approximately 25 mph, apply the vehicle's brakes. If trailer braking is insufficient, increase the max output setting in the brake controller application. If the trailer brakes lock up, decrease the max output. Repeat this process until stops are firm, just short of lock up.

Once the output is set, adjust the sensitivity by driving forward at approximately 25 mph and press the brake pedal. The vehicle and trailer should make a smooth stop. If the stop seems slow and more aggressive braking is desired, increase the sensitivity level through the brake controller application. If the stop seems too aggressive, decrease the sensitivity level in the application.

Make several stops at various speeds and adjust the sensitivity until stops are smooth and firm. Slight adjustment to the output control may also be desirable. **Note:** If any problems occur during setup, refer to the 'Troubleshooting Guide' on the last page of this manual.

LED STATUS INDICATOR

A single LED on top of the Echo® shows the status of the brake controller unit. Refer to the icons and descriptions below.



Device not paired,
no trailer connected
(flashing blue)



Device paired,
no trailer connected
(solid blue)



Calibrating
Echo®
(flashing yellow)



Device not paired,
trailer connected
(flashing green)



Device paired,
trailer connected
(solid green)



Wiring error
(flashing red)



Hardware fault
(solid red)



No power
(no light on)

Indicator	Status
Flashing blue	Device not paired, no trailer connected
Solid blue	Device paired, no trailer connected
Flashing yellow	Calibrating Echo
Flashing green	Device not paired, trailer connected
Solid green	Device paired, trailer connected
Flashing red	Wiring error
Solid red	Hardware fault

CONDITION NOTIFICATIONS

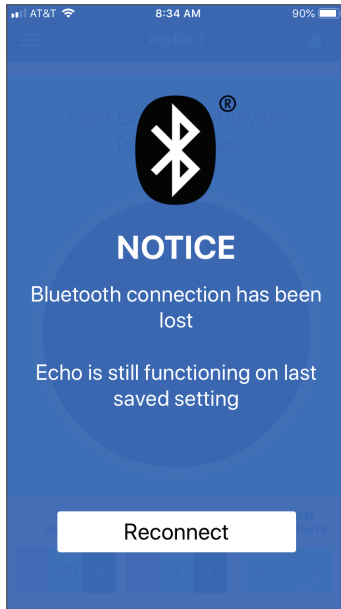

NOTICE If a communication error occurs between the mobile application and the brake controller, the 'Manual Brake Activation', 'Max Output' and 'Sensitivity Level' cannot be adjusted and condition notifications from the brake controller will not be sent. The brake controller will continue to function properly at the most recently programmed settings and braking operation will not be affected.



WARNING If the Echo® detects an overload to the trailer brakes a warning will pop up on your screen. Safely stop the vehicle, disconnect and reconnect the trailer 7-way. If the message reappears, a trailer wiring inspection is recommended.



DANGER If the trailer 7-way has become disconnected from the vehicle a warning will pop up on your screen. Safely stop the vehicle and reinstall your connection. Once connections has been restored, the application will resume with the most recently programmed settings.

BENCH TEST

Parts Needed:

1. Standard 1156 automotive bulb in a socket
2. Charged 12V battery
3. Alligator clip test leads OR wire and wire nuts
4. CURT #51515 / #51516 quick plug with pigtails OR push pins

Note: If a quick plug pigtail is not available, push pins can be used to make a direct connection to the female terminals of the Echo® quick plug housing.

CAUTION Ensure that the brake control wires, quick plug wires, push pins and test leads do not make contact with each other or any other metal surface. Failure to do so may damage the brake control.

Brake Controller Setup

Connect the quick plug to the main module to provide accessible wires for bench testing. Connect the white ground wire of the main module and the ground wire of the bulb to the negative terminal of the 12V battery. Leave the red brake input wire and blue output wire unconnected.

Connect the black battery wire of the main module to the positive terminal of the 12V battery. If the brake control is wired properly and the Echo is operational, the LED display will flash blue.

Ensure the Echo is level to the bench surface and connect the signal wire of the bulb to the blue brake output wire of the Echo.

The LED display will flash green to indicate that it is connected to a trailer but not yet connected to a mobile device. Once unit is connected to a device it will then show a solid green light, and you can proceed to test manual control and accelerometer.

Manual Control Testing

Adjust the Output and the Sensitivity setting to the maximum (+) setting. activate the manual control button on your device the blue ring will go to maximum output then drop to 10% of the ring. while activating the manual control the brightness of the bulb will correspond with the output on the blue ring. Release to deactivate turning off the bulb.

Accelerometer Testing

While keeping the brake controller level, connect the red brake input wire of the main module to the positive terminal of the 12V battery. The brake control output will activate and the bulb may be dimly lit.

Slowly tilt the main module to about 45° and the brightness of the bulb will increase corresponding with the output shown by the brake controller. Slowly tilt the main module back to level and the brightness of the bulb will decrease, corresponding with the output shown by the brake controller.

After testing, disconnect the wiring from the positive terminal of the 12V battery ensuring the exposed contacts do not make contact. If the Echo does not function as described during the above test steps, return the brake controller for service or replacement.

IMPORTANT: Read and follow all warnings and cautions shown on the battery.

RED: BRAKE SIGNAL
Connect red wire when testing accelerometer.

Standard 1156 automotive bulb in lamp socket.

BLUE: BRAKE OUTPUT
Connect after the unit is powered. Reconnect if required during recalibration.

#51515 / #51516: QUICK PLUG

BLACK: BATTERY

WHITE: GROUND

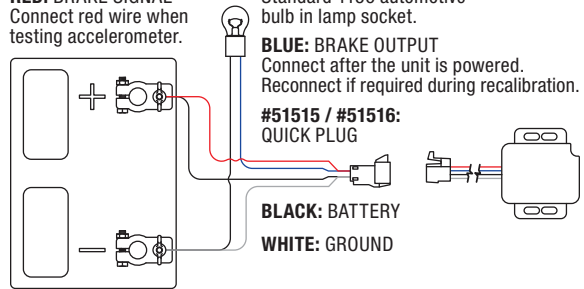

TROUBLESHOOTING - CONNECTING ECHO® UNIT TO THE APP

1. If you see the following error notification: 'Error in Connection: No Device Found', verify distance (see bottom of page 2) and check your unit for a blinking light. If the unit does not show a blinking light, check the connection and / or fuse for trailer brakes per owner's manual.

Selecting 'Stop connecting' will cancel the connection process.

2. Selecting 'Reconnect' will attempt to reconnect to the last Echo used. If you use multiple Echo units, resetting the device allows you to clear the Bluetooth cache and connect to the unit you wish. In order to connect, the Echo unit needs to be connected to a power supply. Some vehicles will not have power until they are running.

The Echo unit must be within the Bluetooth range for the app to connect.

None of the trailer profile setting will be changed upon resetting the Bluetooth cach.

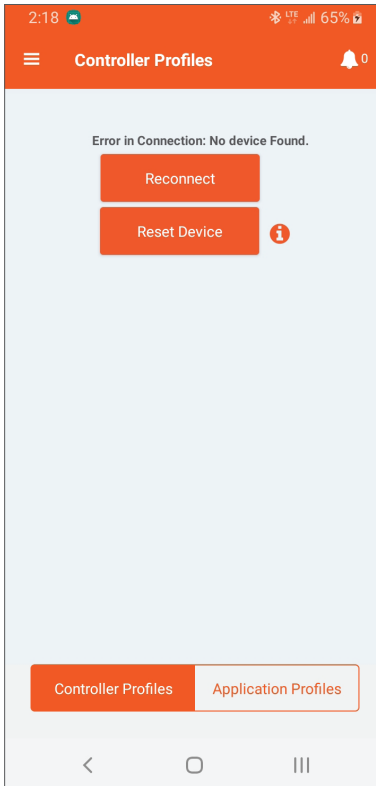
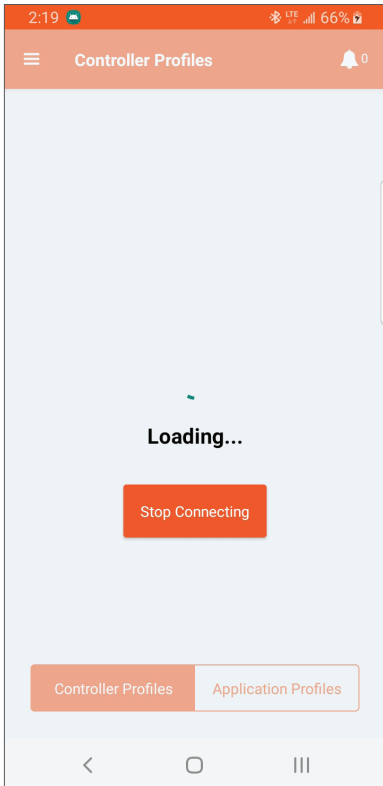

IN-APP INSTALLATION MANUAL

The instruction manuals for the Echo® unit and the manual override button are available to access within the Smart Control app. Select the menu icon in the top left of the app, and then select 'Instructions and User Guides'. From this screen, you can select which instruction manual you would like to view.

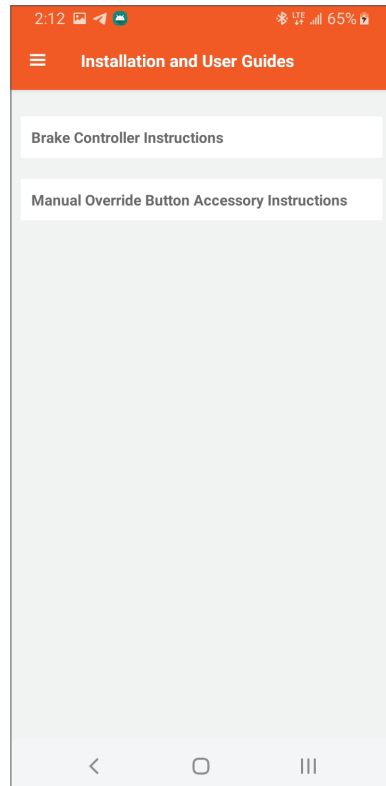
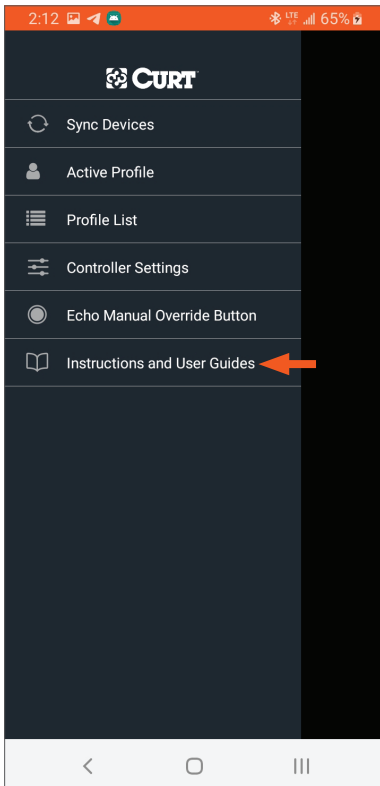
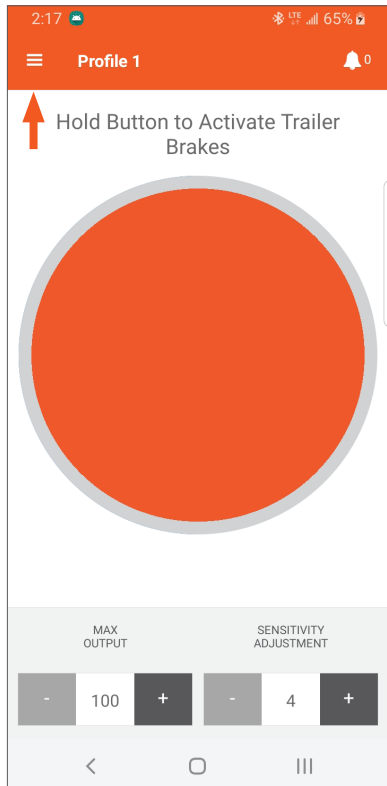

TROUBLESHOOTING GUIDE

Condition	Problem Cause	Possible Solution
LED does not light	No power to brake controller, no ground on vehicle 7-way	Check vehicle power and ground wiring Trailer mode not activated for vehicle Vehicle requires trailer to activate 7-way power
Unable to connect to mobile devices	No power to brake controller, no ground on vehicle 7-way Invalid Bluetooth PIN Bluetooth cache needs to be reset	Check Echo LED status for power Input PIN from label or quick reference card Enable Bluetooth or grant permissions Check smartphone compatibility To reset bluetooth cach, go to the device list at the bottom and select 'Reset Device'- This will not effect previous profile settings, it will only effect the Smart Control app log in
Solid red LED for more than 10 seconds	Hardware fault	Contact CURT Product Support
Flashing red LED	Contamination in trailer plug socket	Check for clean and dry trailer plug
	Short in trailer brake wiring	Locate and correct short
	Accelerometer error	Unplug the brake controller and plug it back in
	Short or overload in trailer brakes	Troubleshoot trailer brake circuit per brake manufacturer's instructions
No trailer brakes, pedal or manual	Mis-wired 7-way connector Improper or corroded trailer wiring Weak or missing ground	Confirm vehicle and trailer 7-way connections
No trailer brakes, pedal or manual (device notification of error)	Loss of trailer connection, unplugged or bad wiring	Confirm vehicle and trailer 7-way connections
No response on manual override or brake output	Mis-wired 7-way connector Improper or corroded trailer wiring No or intermittent power to brake controller Weak or missing ground Wireless connectivity error	Confirm vehicle and trailer 7-way connections Check Bluetooth and application settings
Reduced braking power on manual override or brake output	Weak or missing ground Improper max power or sensitivity settings Improper or corroded trailer wiring	Confirm vehicle and trailer 7-way connections Check Bluetooth and application settings Increase max power or sensitivity settings
Trailer brakes on all the time (LED shows red)	Mis-wired 7-way trailer connector	Confirm vehicle and trailer 7-way connections
App signals 'low voltage'	Low battery voltage	Check vehicle battery and replace if needed Confirm vehicle 7-way connections and wiring
App signals a 'disconnect'	Trailer connector is disconnected	Reconnect the trailer connector Confirm vehicle 7-way connections and wiring
App signals 'overload'	Trailer brakes are overloaded	Reconnect the trailer connector Confirm vehicle 7-way connections and wiring Check trailer brake wiring for short circuits

PRODUCT REGISTRATION

CURT stands behind our products with industry-leading warranties. To get copies of the product warranties, register your purchase or provide feedback, visit: warranty.curtgroup.com/surveys

LET US KNOW WHAT YOU THINK!

Share the love and your experience with Echo by leaving a review on curtmg.com/51190.

