



**BLUE OX®**

**BX2633**

2012-14 Ford Focus S, SE, SEL, Titanium Hatchback & Sedan (No Adaptive Cruise) Installation Instructions

Attachment Tab Height: 14-1/2"

Attachment Tab Width: 17-1/2"

Serial Number

Please read **BOTH** these Installation Instructions and the General Information sheet prior to installing or operating this equipment.

- Blue Ox® towing products and accessories are intended to be installed by Blue Ox® Dealers who are familiar with our products and have the equipment and knowledge necessary to do "fit work". If needed, Blue Ox® Dealers can be found at [www.blueox.com](http://www.blueox.com) or by contacting our Technical Service Department at (402) 385-3051.
- Many Blue Ox® baseplates are designed to use existing holes and hardware to mount the baseplate to the towed vehicle. Even though bolts are there, do not assume they are adequate for baseplate mounting. Always use the hardware supplied in the hardware kit and existing hardware as specified in the installation instructions.

**Bolt Torque Specifications**

Torque in Foot-Pounds for Inch Bolts

Bolt Size	Grade 5	Grade 8
1/4"	10	14
5/16"	19	29
3/8"	33	47
7/16"	54	78
1/2"	78	119
5/8"	154	230
3/4"	257	380



If the front of your vehicle looks different than this, please contact us at (402)385-3051.

**Reference your vehicle owner's manual for manufacturer's towing specifications.**

**Bolt Torque Specifications**

Torque in Foot-Pounds for Metric Bolts

Bolt Size	Grade 8.8	Grade 10.9
6MM	6	8
8MM	16	22
10MM	31	40
12MM	54	70
14MM	89	117
16MM	161	230
18MM	222	318



**WARNING**

Failure to read and follow these instructions could result in separation of the towed vehicle from the tow bar, causing property damage, loss of towed vehicle, personal injury or death.

BX2633  
2012-14 Ford Focus S, SE, SEL, Titanium  
Hatchback & Sedan (No Adaptive Cruise)  
Installation Instructions

**Instruction Notes:** The fascia, bellypan and windshield washer fluid reservoir are removed and reinstalled for the baseplate installation. Some drilling and trimming is required.

Place all components that are removed on a flat, sturdy surface. All items will be reinstalled unless otherwise noted after the baseplate is installed.

The dimensional variations between otherwise identical vehicles can be considerable. While the baseplate was designed for easy installation, it may be necessary to tailor the baseplate slightly to compensate for vehicle manufacturer's tolerances.

The BX8869 Tail Light Wiring Kit is recommended for this vehicle.

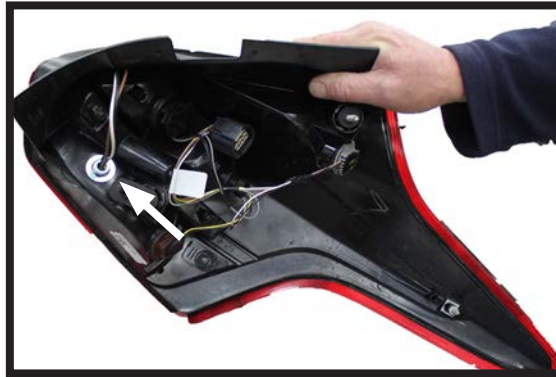

Drill a hole according to the tail  
light wiring kit instructions.

### **NOTICE**

- Handling of some cosmetic parts when installing this product may require the use of protective covers, rags, specialty tools, etc. to prevent damage.
- When using power drills be aware of the dangers of torque and drill bit length.
- When using a reciprocating saw be aware of objects behind the cutting surface.
- Use a good quality paint to spray cut edges of frame to prevent rusting.
- Be sure that **ALL** electrical connections are plugged in and accessories are functioning properly before reinstalling the fascia.
- The baseplate is computer tested to your vehicle's GVWR, exceeding this weight will void the manufacturer's warranty.
- Be sure to use a sufficient amount of Loctite® Red on all bolt threads before tightening. Tighten all bolts according to the torque chart provided.
- Dealer or installer be certain the user receives these instruction sheets.
- If the baseplate is in an accident, it must be replaced. **DO NOT** use it again! An accident can cause unseen damage and using it again could result in more damage or serious injury. **DO NOT** use the baseplate if it is damaged or missing parts.

**BX2633**  
**2012-14 Ford Focus S, SE, SEL, Titanium**  
**Hatchback & Sedan (No Adaptive Cruise)**  
**Installation Instructions**

- Tools Required**
- Large Vise Grip
  - Flat Screwdriver
  - Utility Knife
  - Torque Wrench
  - Drill
  - Reciprocating Saw
  - Tape Measure
  - Loctite® RED
  - 13/32" Drill Bit
  - 1-1/4" Hole Saw
  - T27 Torx
  - T30 Torx
  - 8MM Socket
  - 10MM Socket
  - 9/16" Socket

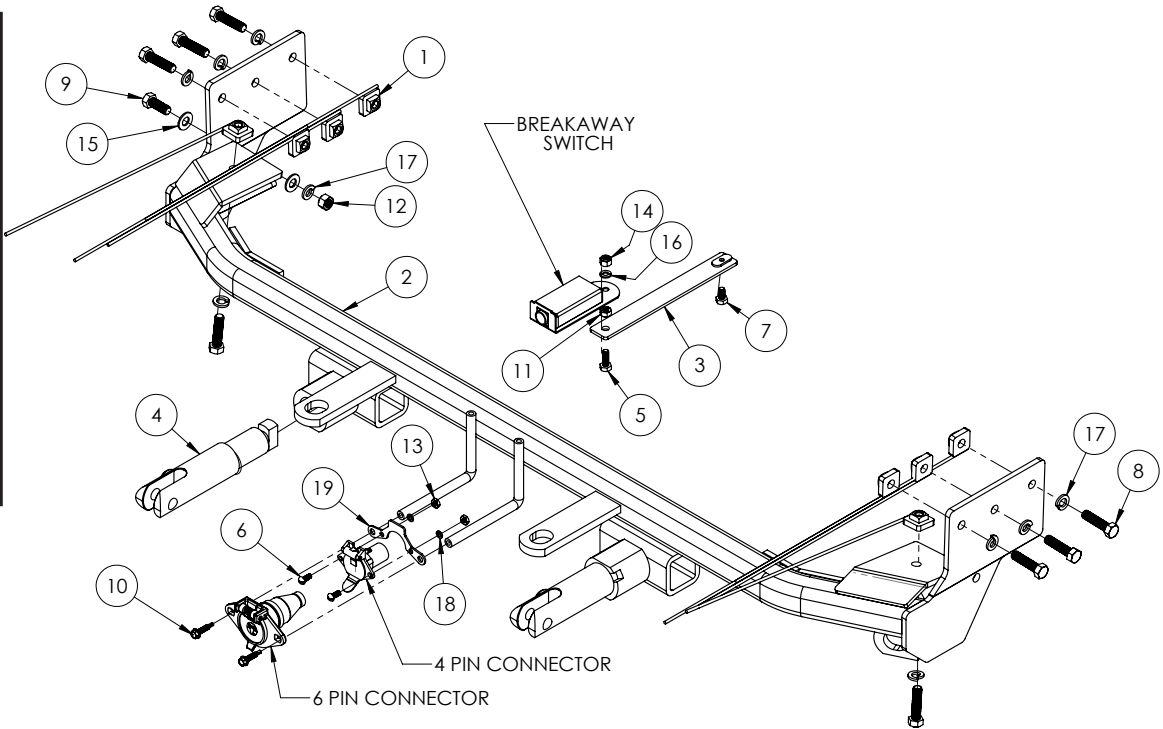

Item No.	Part No.	Description	Qty.
1.....	61-5208.....	3/8"-16 Nut Plate.....	8
2.....	61-6913.....	BX2633 Baseplate.....	1
3.....	61-6914.....	Mount Bracket.....	1
4.....	62-3468.....	Attachment Tab Assembly with Hole.....	2
5.....	201-0050.....	1/4"-20 x 3/4" Hex Head Bolt, Grade 5, ZP.....	1
6.....	201-0192.....	#10-32 1/2" Round Slotted Head Screw.....	2
7.....	201-0193.....	1/4"-20 x 1/2" Hex Head Bolt, Grade 5, ZP.....	1
8.....	201-0440.....	3/8" - 16 x 1-1/2" Hex Head Bolt, Grade 5, ZP.....	8
9.....	201-0443.....	3/8"-16 x 1" Hex Head Bolt, Grade 5, ZP.....	1
10.....	201-0979.....	#12-14 x 1" Self Drilling Screw, ZP.....	2
11.....	202-0001.....	1/4"-20 Hex Nut, ZP.....	1
12.....	202-0003.....	3/8"-16 Hex Nut, ZP.....	1
13.....	202-0047.....	#10-32 Hex Nut.....	2
14.....	202-0102.....	1/4"-20 Hex Nylon Nut, ZP.....	1
15.....	203-0003.....	3/8" Flat Washer, ZP.....	2
16.....	203-0008.....	1/4" Lock Washer, ZP.....	1
17.....	203-0010.....	3/18" Lock Washer, ZP.....	9
18.....	203-0054.....	#10 Lock Washer, ZP.....	2
19.....	299-0685.....	Electrical Bracket, ZP.....	1
20.....	226-0046(not shown).....	Class III Safety Cables.....	2
21.....	229-0359(not shown).....	3/8" Quicklink, ZP.....	4
22.....	290-0437(not shown).....	Black Cap Plug Receiver.....	1

**Important:**

Use only genuine factory replacement parts on your baseplate. Do **NOT** substitute homemade or non-typical parts. If a bolt is lost or in need of replacement, for your safety and the preservation of your baseplate, be sure to use a replacement bolt of the same grade (In most cases it will be Grade 5, please reference the parts list above). Replacement parts may be ordered through your nearest Blue Ox® Dealer or Distributor. Failing to follow and/or altering these installation instructions in either installation or required equipment will void the manufacturer's warranty. Towing behind a non-motorized vehicle will void the warranty.

BX2633  
2012-14 Ford Focus S, SE, SEL, Titanium  
Hatchback & Sedan (No Adaptive Cruise)  
Installation Instructions

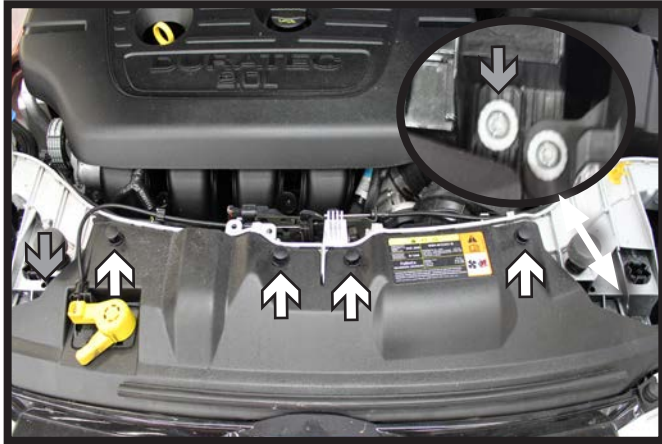

1. From the top of the fascia, using a T30 Torx, remove the inner-most bolt from each side (gray arrow). Remove the four (4) push pins (white arrows).

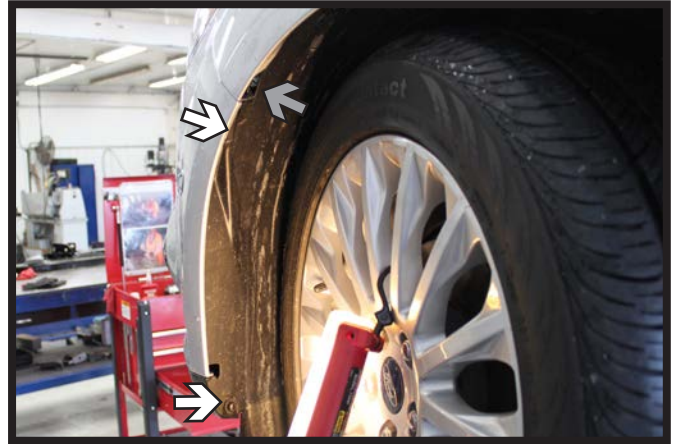

2. Using a T27 Torx, remove the two (2) screws from the driver's side front wheel well (white arrows). Remove the push pin from the driver's side front wheel well (gray arrow). Repeat this on the passenger's side.

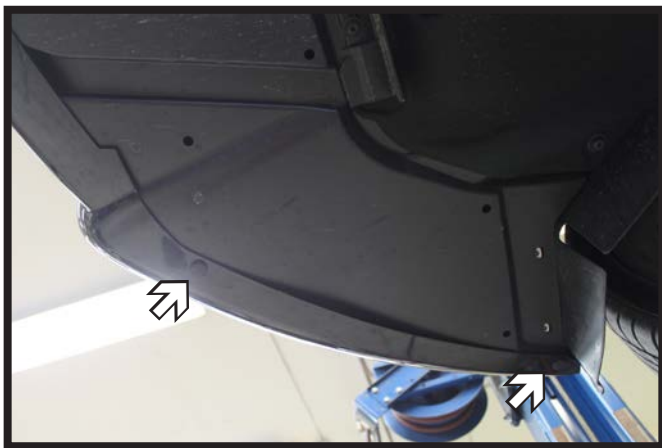

3. On the underside of the fascia remove the two (2) pushpins from the outer edge. Repeat this on the other side of the vehicle.



4. On the underside of the fascia remove the two (2) pushpins from the front outer edge.



BX2633  
2012-14 Ford Focus S, SE, SEL, Titanium  
Hatchback & Sedan (No Adaptive Cruise)  
Installation Instructions



5. Using a flat screwdriver, pry the black hood latch cable out of the black mounting bracket (white arrow). Then rotate the wire left to release it.



6. On the driver's side, locate the running lights main electrical cord and disconnect. Under both headlights release the tabs from the body and carefully remove the fascia.

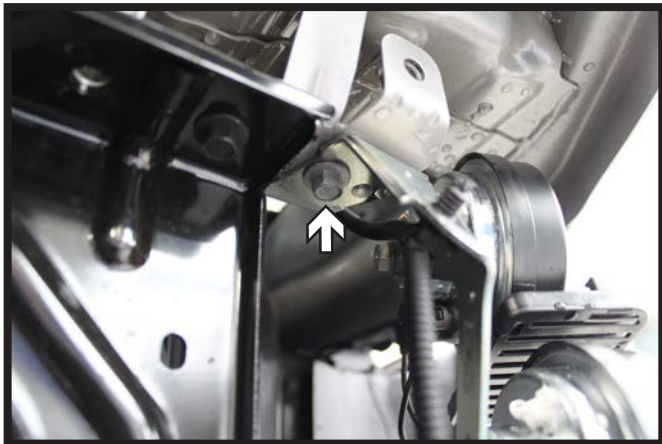

7. Using a 10MM socket, remove the bolt from the passenger's side horn bracket. Disconnect and set horn bracket aside.

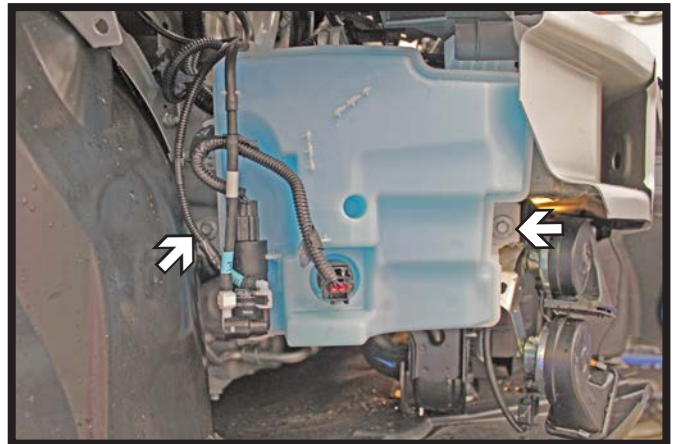

8. Using a 10MM socket, remove the two (2) bolts from the washer reservoir on the passenger's side. Disconnect all electrical connections. Remove and plug the fluid lines.

BX2633  
2012-14 Ford Focus S, SE, SEL, Titanium  
Hatchback & Sedan (No Adaptive Cruise)  
Installation Instructions

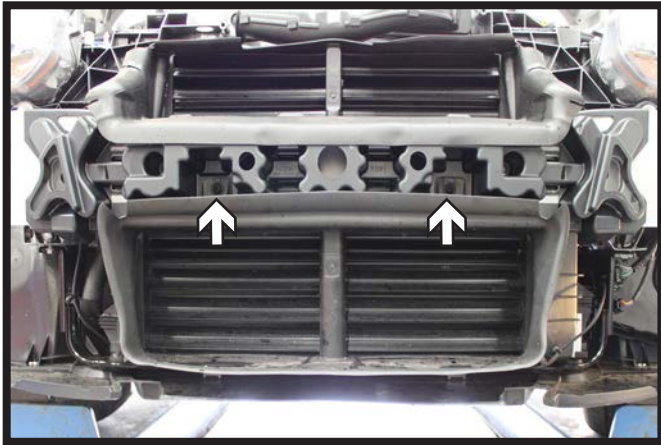

9. Using a T30 Torx, remove the flexible intake cover.



10. On the front bumper, using a 1-1/4" hole saw, slowly drill a hole centered vertically and horizontally on the flat area as shown. Do this on both sides of the vehicle. NOTE: The hole cut is used to place nut plates for future steps and if available the use of a carbide-tipped holesaw is recommended.

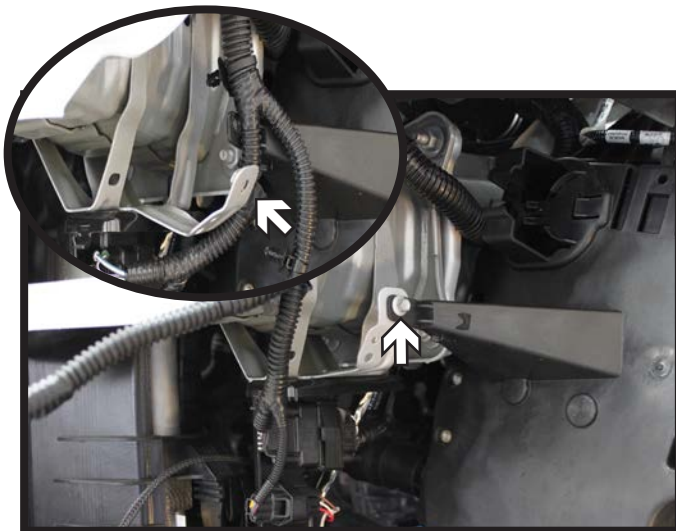

11. On the driver's side, use a 8MM socket to remove the bolt from the frame webbing. Once the bolt is removed, bend the webbing outward with a pair of large vice grips far enough to fit the baseplate on top of it.

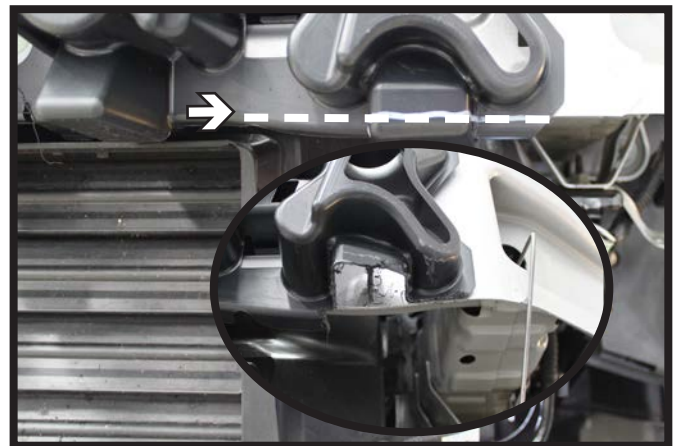

12. On the plastic bumper cover, using a utility knife, trim the lower outer edge flush with the bottom of the bumper. Repeat on the other side of the vehicle.



BX2633  
2012-14 Ford Focus S, SE, SEL, Titanium  
Hatchback & Sedan (No Adaptive Cruise)  
Installation Instructions

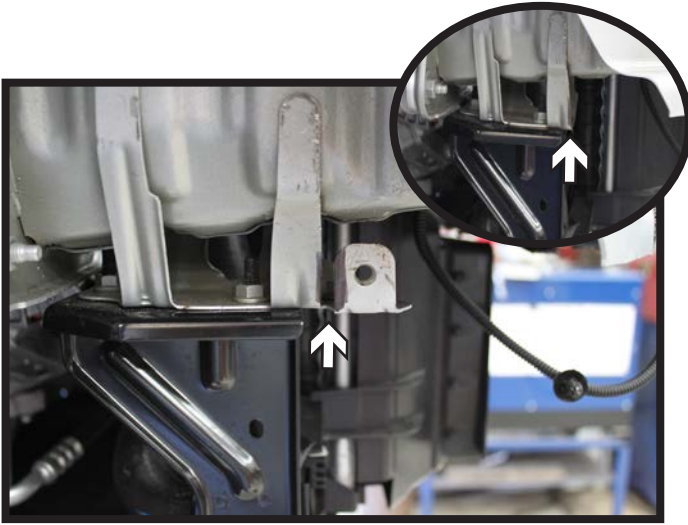

13. On the passenger's side only, use a reciprocating saw to remove the washer reservoir bracket and horn front bracket.

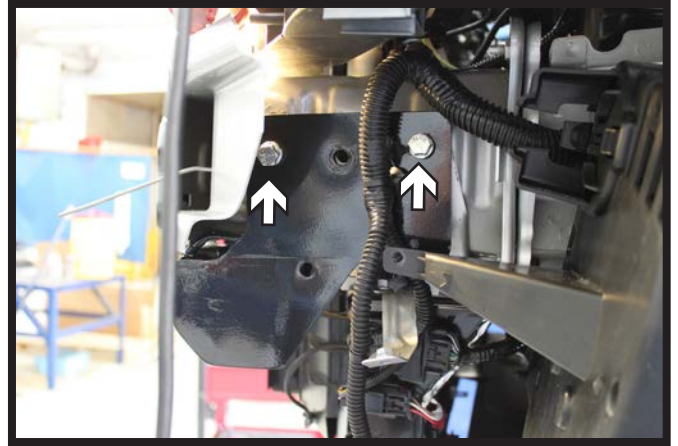

14. On the driver's side, slide the baseplate on top of the bracket we bent down earlier until the top back hole is aligned with the top back existing hole on the frame webbing. Insert a 3/8"-16 x 1-1/2" hex bolt and 3/8" lock washer with a 3/8"-16 nut plate. Also secure the top front hole the same way. **DO NOT** tighten bolts all the way, wait until directed to do so. Do this on both sides of the vehicle.

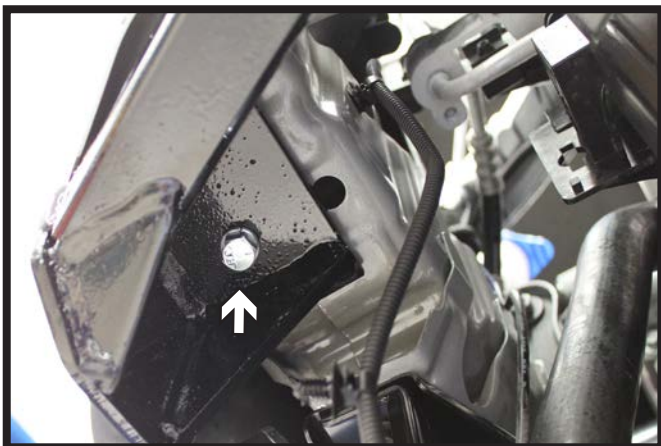

15. Using the baseplate as a template, drill a hole through the bottom of the frame webbing using a 13/32" drill bit. Do this on both sides of the vehicle. Insert a 3/8"-16 x 1-1/2" hex bolt with a 3/8" lock washer and 3/8"-16 nut plate through the hole on the bottom of the baseplate. Make sure baseplate is level, then tighten. Do this to both of the bottom holes **FIRST**, then tighten the two (2) top bolts on each side (14).

BX2633  
2012-14 Ford Focus S, SE, SEL, Titanium  
Hatchback & Sedan (No Adaptive Cruise)  
Installation Instructions

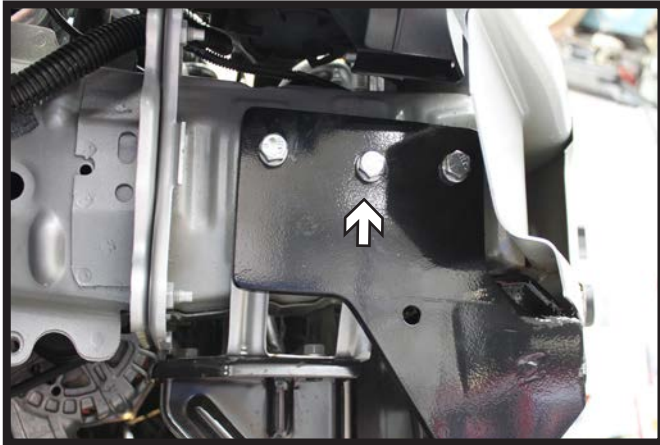

16. If necessary, drill a hole through any obstruction from frame webbing in the middle hole of the baseplate with a 13/32" drill bit. Insert a 3/8"-16 x 1-1/2" hex bolt and 3/8" lock washer with a 3/8"-16 nut plate. Do this on both sides.

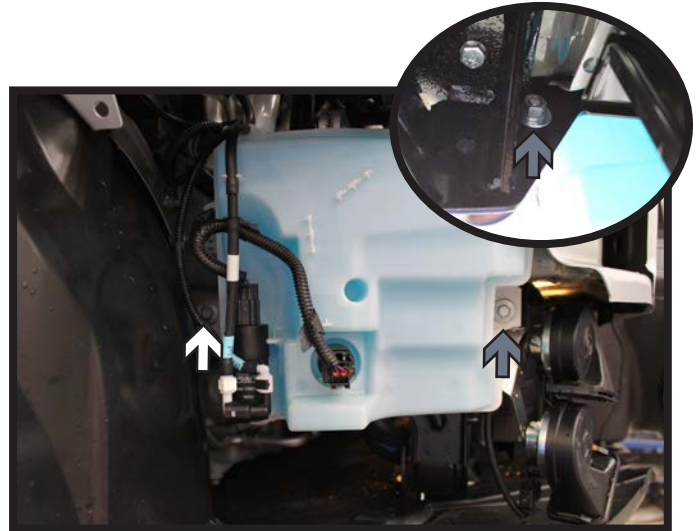

17. Reattach the washer reservoir on the passenger's side. Use the existing bolt in the back (white arrow). Then a 3/8"-16 x 1" hex bolt with a 3/8" flat washer and a 3/8" hex nut in the front hole thru the baseplate (gray arrow).

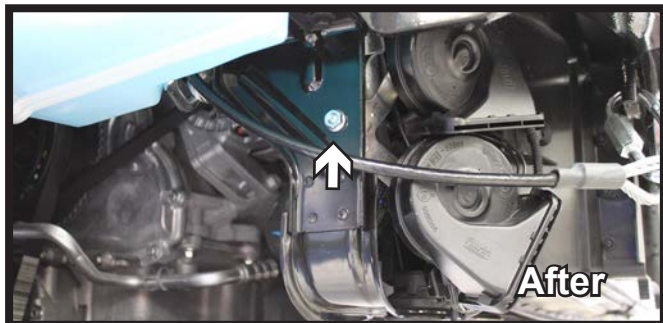
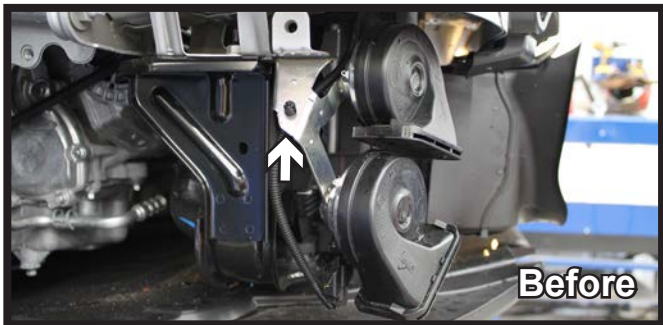

18. To reattach the horn, use the existing hole in the frame webbing on the passenger's side and the existing hole on the horn bracket, insert a 1/4"-20 x 3/4" hex bolt with a 1/4" lock washer and 1/4"-20 nut. Reattach all electrical connections.

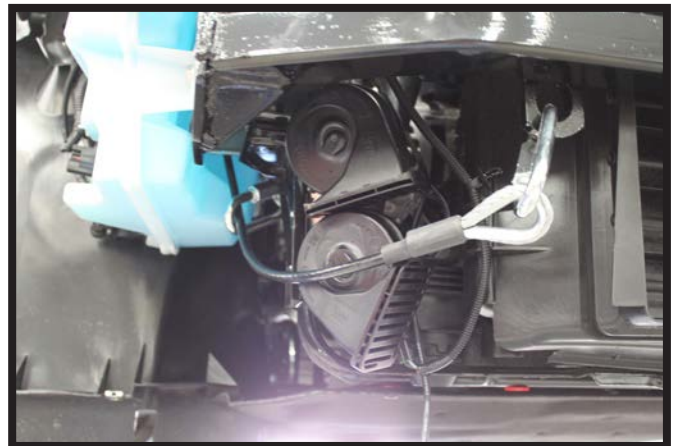

19. Attach the permanent baseplate safety cables to the provided convenience link on the baseplate. The photo above shows the recommended installation of the cables to frame of vehicle. Additional options may interfere with suggested mounting; in this case, secure the cables to a solid piece of the frame as described in the instructions included with the permanent baseplate safety cables. Be sure the safety cables do not rub against any hoses or moving parts. Do this on **BOTH** sides of the vehicle.



BX2633  
 2012-14 Ford Focus S, SE, SEL, Titanium  
 Hatchback & Sedan (No Adaptive Cruise)  
 Installation Instructions

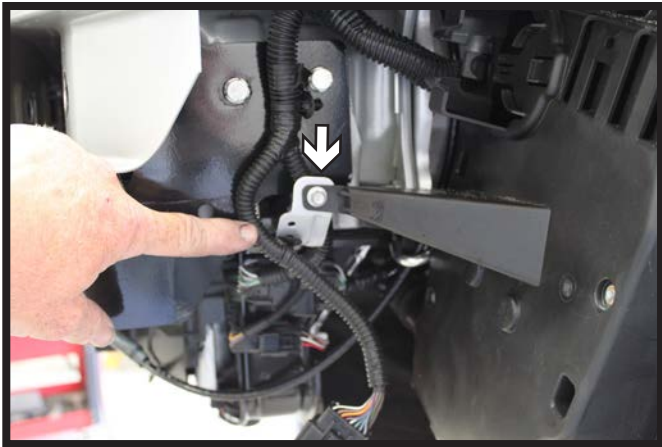

20. Bend the bracket back to its original location and reinstall the existing bolt.



21. To reattach the intake cover, use a utility knife to cut from the back upper corner of the side wall a 2 1/2" x 1 1/2" rectangle from each side of the cover. Reinstall using the two (2) T30 Torx bolts. NOTE: If a breakaway will be installed, install the breakaway before installing cover. Be sure that bottom of the cover goes below the breakaway bracket.

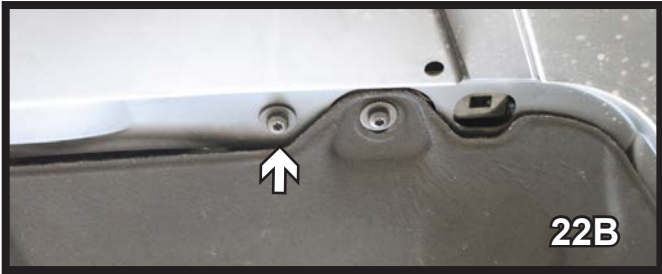
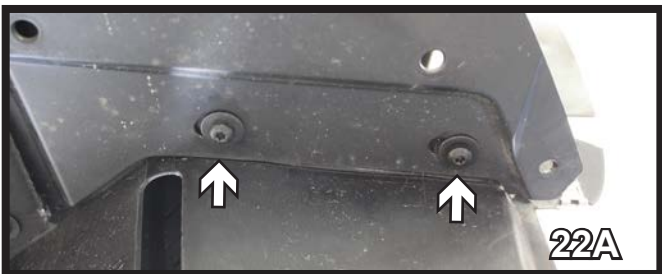

22. **Optional:** To install a breakaway switch, you must remove the belly pan with a T30 Torx. Remove the two (2) screws from in front of both the driver's and passenger's side tires (22A) then follow the pan toward the middle of the vehicle removing the three (3) specified bolts (22B and 22C).

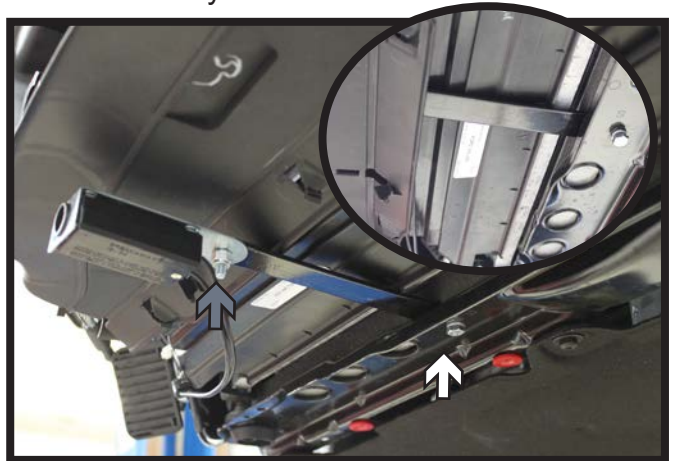

23. **Optional:** Using a 1/4"-20 x 1/2" hex bolt with a 1/4" lock washer, attach the breakaway bracket to an existing hole on the frame webbing, just slightly toward the passenger's side of the vehicle (white arrow). Attach the breakaway using a 1/4"-20 x 3/4" bolt, 1/4" spacer nut, and a 1/4"-20 nylon nut (gray arrow). Attach all electrical connections and reinstall the belly pan. NOTE: Breakaway should stick out the bottom of the fascia once reinstalled.

BX2633  
2012-14 Ford Focus S, SE, SEL, Titanium  
Hatchback & Sedan (No Adaptive Cruise)  
Installation Instructions



23. Align the fascia as close to its original position and trim the opening for the attachment tabs with a utility knife. Reinstall the fascia.

## CUSTOMER SERVICE COMMITMENT

Blue Ox® is committed to providing you with exceptional customer care throughout your lifetime with our products. Our team is here to assist you with any questions you may have regarding the performance of your product. Simply call (402) 385-3051 and you can speak with our technical service team.

Additionally, please visit our website to see which rallies our Destination America team will be attending. For a nominal fee, our service technician will service your towing system to ensure it's in proper working condition. Also, as a commitment to our customers, should you visit our factory, you can stay at our full service Blue Ox® campground at no charge along with enjoying a factory tour.

Again, thank you for being our customer and for the confidence you have shown in the performance of our products. It is because of customers like you we enjoy the success we have today.

© 2016 Blue Ox  
One Mill Road, Industrial Park  
Pender, Nebraska 68047  
Phone: (402) 385-3051  
Fax: (402) 385-3360  
www.blueox.com

# General Information

1. Ensure that your product(s) are registered online at [www.blueox.com](http://www.blueox.com). It is crucial to register your product(s) so that you may be alerted of product offerings, updates, upgrades, maintenance and safety bulletins, and/or recalls.
2. **It is the owner's responsibility to inspect all towing equipment for cracked welds, missing or worn parts and loose bolts before each towing trip.** Be sure to use Loctite® Red on all bolts and tighten to the recommended specifications.
3. **It is the owner's responsibility to hook up all towing equipment per manufacturer's instructions/recommendations.**
4. Remove the attachment tabs when not in use (if applicable).

## Notice To Baseplate Installer

### 1. It is YOUR responsibility to watch for:

- Oil cooler and air conditioner lines
- Electrical wires and hoses
- Missing parts or attaching points on the frame

\*\* If the baseplate is improperly installed and is against a wire or hose, it could cause fluid leaks or electrical shorts some time after the actual baseplate installation.

## Permanent Baseplate Safety Cable Installation

Permanent baseplate safety cables are strongly recommended when towing a vehicle with a tow bar. The principle function of the permanent baseplate safety cables is to prevent the towed vehicle from breaking loose in the event the connection between the frame of the towed vehicle and the baseplate fails or becomes disconnected. The cables must be connected from the baseplate to the frame rail or cross member of the vehicle's frame. The illustrations below show the possible arrangements recommended by Blue Ox®. Each permanent baseplate safety cable must have an adequate weight rating for the towing system. The weight rating of the two (2) cables together will not qualify.

***Do not mount the permanent baseplate safety cables against wires, hoses or brake lines.***

These permanent baseplate safety cables should remain installed as long as the baseplate is installed on the vehicle. Permanent baseplate safety cables are to be used in conjunction with, and NOT a replacement for legally required safety cables attaching the towed vehicle to the towing vehicle.

### OPTION #1

Permanent Baseplate Safety Cables to Cross Member or Frame of Towed Vehicle.

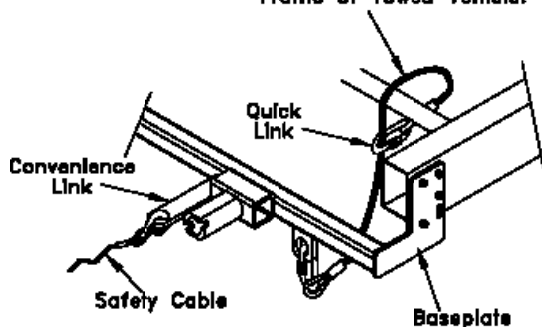

### OPTION #2

Permanent Baseplate Safety Cables to Cross Member or Frame of Towed Vehicle.

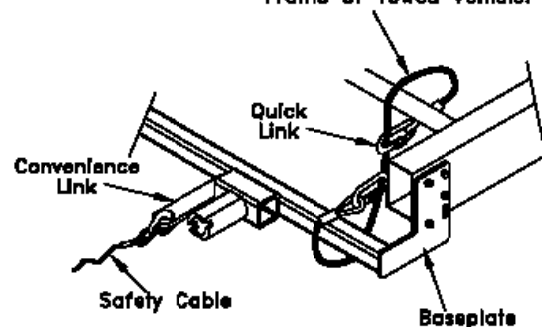



# BLUE OX ORIGINAL PURCHASERS THREE YEAR LIMITED WARRANTY

Automatic Equipment Manufacturing Company ("Automatic") warrants to the original (first) retail purchaser that this product, manufactured by Automatic, shall be free from defect in material and workmanship under normal use and service for a period of three years from the date of delivery.

During said three-year period, Automatic will repair or replace any parts that have been returned by the original purchaser, to the factory, transportation prepaid, and in Automatic's sole and absolute opinion found to be defective.

Limitations on Warranty Coverage:

Coverage under this warranty will be valid only if the customer warranty card is returned by the original purchaser within 30 days of purchase.

Coverage under this warranty will be effective only when a copy of the original invoice, showing date and place of purchase, accompanies any claim for warranty. This warranty is NON TRANSFERABLE.

This limited warranty will not cover, in any way or form, any alleged damages caused by incorrect or improper installation, improper use, modification or neglect of product, failure to properly service and maintain, misuse, act of God, accident or failure of the user to follow guidelines contained in the instructional material provided by Automatic.

This warranty does not cover normal wear and tear, paint or rust.

Warrantor assumes no responsibility to the owner for loss of use of product, loss of time, inconvenience or any other damage consequential or otherwise. Including, but not limited to mileage, expense of transporting of product, return shipping expense, mechanics travel time, telephone, road service, towing, and rental during repairs, travel, lodging, loss or damage to personal property or loss of earnings.

**REPAIR OR REPLACEMENT AS SET FORTH IN THIS LIMITED WARRANTY IS THE SOLE EXCLUSIVE REMEDY OF THE PURCHASER. AUTOMATIC SHALL NOT BE LIABLE FOR ANY INCIDENTAL OR CONSEQUENTIAL DAMAGES FOR BREACH OF ANY EXPRESS OR IMPLIED WARRANTY ON THIS PRODUCT. EXCEPT TO THE EXTENT PROHIBITED BY APPLICABLE LAW, ANY IMPLIED WARRANTY OF MERCHANTABILITY OR FITNESS FOR A PARTICULAR PURPOSE ON THIS PRODUCT IS LIMITED IN LENGTH TO THE DURATION OF THIS WARRANTY.**

Please visit <http://blueox.com/warranty/> to register your warranty

