



BX2614

2010-12 Ford Fusion (Includes Hybrid) 2011-12 Lincoln MKZ Hybrid Installation Instructions

Serial Number

Please read BOTH these Installation Instructions and the General Instructions before attempting to install or operate this equipment.

- Blue Ox® towing products and accessories are intended to be installed by Blue Ox® Dealers who are familiar with our products and have the equipment necessary and knowledge to do “fit work”. When necessary Blue Ox® Dealers can be found at www.blueox.com or by contacting our Customer Care Department at (402) 385-3051.
- Many Blue Ox® baseplates are designed to use existing holes and hardware to mount the baseplate to the towed vehicle. Even though bolts are there, do not assume they are adequate for baseplate mounting. Always use hardware supplied in the hardware kit and existing hardware specified in the Baseplate Installation Instructions.

Attachment Tab Height: 14-3/4”
Attachment Tab Width: 19-1/2”

| Bolt Torque Specifications | | |
|--|-----------|------------|
| Torque in Foot-Pounds for Metric Bolts | | |
| Bolt Size | Grade 8.8 | Grade 10.9 |
| 6MM | 6 | 8 |
| 8MM | 16 | 22 |
| 10MM | 31 | 40 |
| 12MM | 54 | 70 |
| 14MM | 89 | 117 |

Confirm the towability and pre-towing procedures for your vehicle with the owner’s manual or contact the vehicle’s manufacturer for specific towing procedures.

| Bolt Torque Specifications | | |
|--------------------------------------|---------|---------|
| Torque in Foot-Pounds for Inch Bolts | | |
| Bolt Size | Grade 5 | Grade 8 |
| 1/4” | 10 | 14 |
| 5/16” | 19 | 29 |
| 3/8” | 33 | 47 |
| 7/16” | 54 | 78 |
| 1/2” | 78 | 119 |
| 5/8” | 154 | 230 |



If the front of your vehicle looks different than this, call us at (402) 385-3051.

BX2614

2010-12 Ford Fusion (Includes Hybrid)

2011-12 Lincoln MKZ Hybrid

Installation Instructions

Parts List

| Ref. No. | Qty. | Part # | Description |
|----------|------|----------|---|
| 1 | 1 | 61-6661 | Weldment, BP, BX2614 |
| 2 | 2 | 61-5208 | 3/8-16 Nut Plate, with 14" Wire |
| 3 | 6 | 107-2683 | Spacer Tube, 3/4 X .406 (ID)X 1" |
| 4 | 4 | 201-0444 | 3/8-16 X 2 Hex Bolt Grade 5, ZP |
| 5 | 2 | 201-0440 | 3/8-16 X 1 1/2 Hex Bolt, Grade 5, ZP |
| 6 | 6 | 203-0010 | 3/8" Lock Washer, ZP |
| 7 | 4 | 202-0090 | 3/8-16 Hex Nyl. Ins. Lock Nut, ZP |
| 8 | 2 | 201-0553 | 1/4-20 x 1/2" Hx. Wshd, Type F Screw |
| 9 | 2 | 201-0192 | #10-32 x 1/2" Slot, Rd. Hd. Screw |
| 10 | 2 | 203-0054 | #10 Lock Washer |
| 11 | 2 | 202-0047 | #10-32 Hex Nut |
| 12 | 2 | 101-5822 | Adapter, 4 Way Connector |
| 13 | 2 | 62-3469 | Attachment Tab Assembly, Rem, SF/LB, 1 Hole |
| 14 | 2 | 201-0050 | 1/4-20 X 3/4 Hex Bolt, Grade 5, ZP |
| 15 | 2 | 202-0102 | 1/4-20 Hex Nylon Nut, ZP |
| 16 | 1 | 102-7177 | Breakaway Bracket BX2614 |
| | 2 | 201-0702 | 6MM-1.00 X 45MM Hex Bolt, Grade 8.8 (Not Shown) |
| | 2 | 203-0161 | 6MM, Lock Washer, ZP (Not Shown) |
| | 2 | 203-0001 | 1/4 Flat Washer, ZP (Not Shown) |
| | 2 | 226-0046 | Baseplate Safety Cable, 36" CL III (Not Shown) |
| | 2 | 229-0359 | Quicklink, 3/8, ZP (Not Shown) |
| | 2 | 290-0437 | Cap Plug, Black (Not Shown) |

Tools Required

| | |
|--------------------|------------------|
| 7MM Socket | Utility Knife |
| 10MM Socket/Wrench | Pliers |
| 9/16" Socket | Tape Measure |
| Large Vise Grips | 1 1/4" Hole Saw |
| Drill | 13/32" Drill Bit |
| Flat Screwdriver | Loctite® Red |

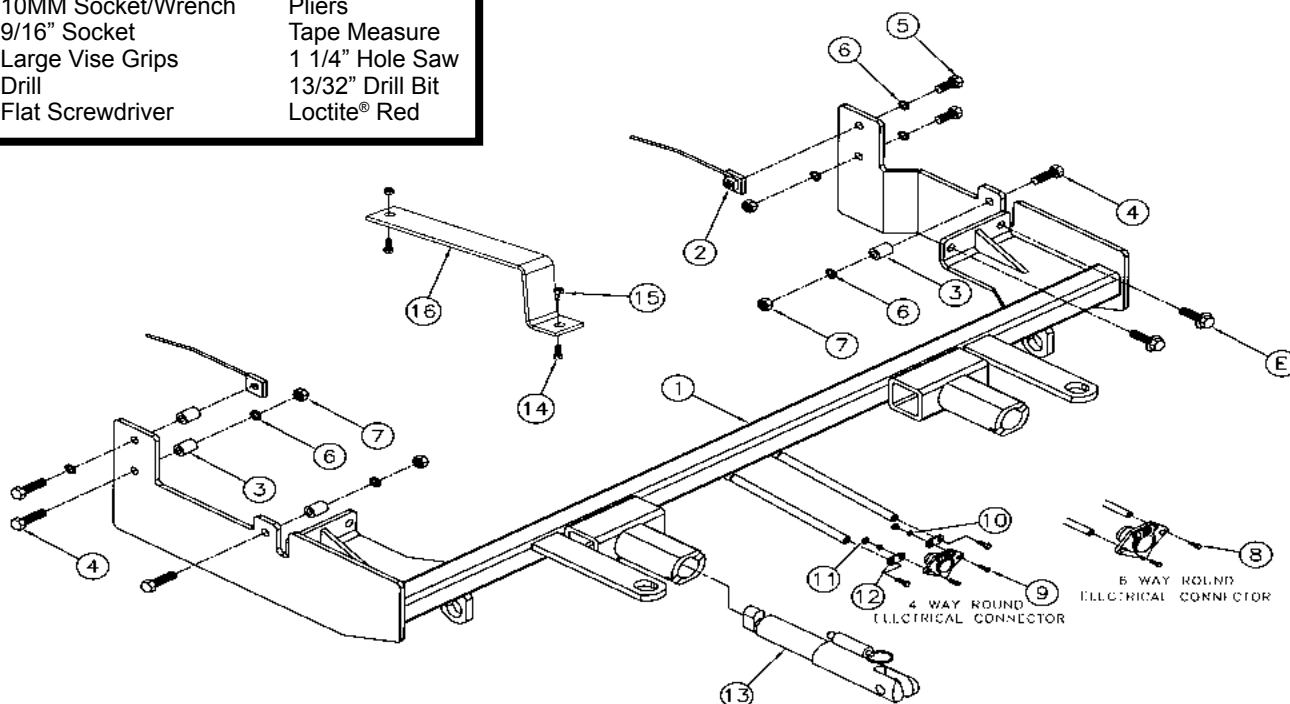

Important:

Use only genuine factory replacement parts on your baseplate. Do **NOT** substitute homemade or non-typical parts. If a bolt is lost or in need of replacement, for your safety and the preservation of your baseplate, be sure to use a replacement bolt of the same grade (In most cases it will be Grade 5, please reference the parts list above). Replacement parts may be ordered through your nearest Blue Ox® Dealer or Distributor. Failing to follow and/or altering these installation instructions in either installation or required equipment will void the manufacturer's warranty. Towing behind a non-motorized vehicle will void the warranty.

BX2614
 2010-12 Ford Fusion (Includes Hybrid)
 2011-12 Lincoln MKZ Hybrid
 Installation Instructions

Attachment Tabs: Motorhome mount tow bars are recommended for use with this baseplate. Due to the design of the removable tabs, the RangeFinderII, Adventurer, Acclaim, and Ambassador tow bars can not be used. Adapters, except the BX8833 and BX88151, can not be used with this baseplate.

Installation Notes: The front fascia, plastic bumper cover, air baffle, washer reservoir and bumper guards are removed during installation. Drilling is required. The bumper cover, fascia, air baffle and washer reservoir must be trimmed.

The dimensional variations between otherwise identical vehicles can be considerable. While the baseplate was designed for easy installation, it may be necessary to tailor the baseplate slightly to compensate for auto manufacturer's tolerances. These minor adjustments may include filing a hole slightly, bending electrical rods or bending end plates.

The BX8869 Bulb and Socket Wiring Kit is recommended for Ford Fusion models

The BX8848 4-Diode Wiring Kit is recommended for Lincoln MKZ models

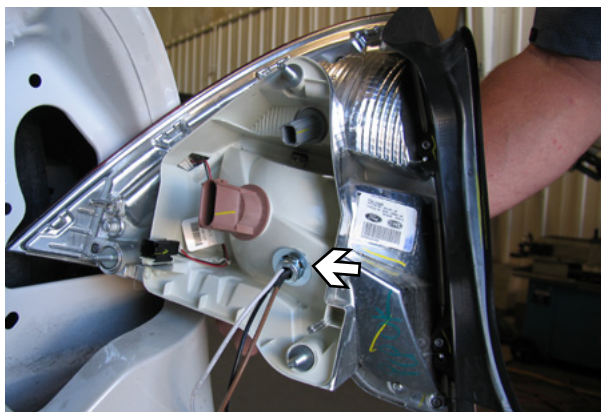

Possible location for the BX8869 Bulb and Socket Wiring Kit.

Handling of some cosmetic parts when installing this product may require the use of protective covers, rags, specialty tools, etc. to prevent damage.

Do not use the towed vehicle for storing luggage, equipment, etc. This may cause you to exceed the towing capacity of the tow bar, baseplate, and its accessories.

Installation Instructions:



1. Use a 10MM socket to remove two (2) metric bolts from the top of the fascia (white arrows). Remove one (1) push pin from the top of the fascia (gray arrow). Do this to both sides of the vehicle. Set bolts and push pin aside to be reinstalled later.

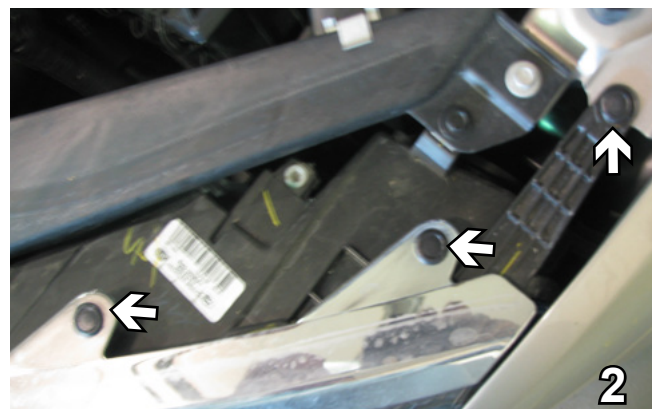

2. Remove three (3) push pins from the top of the fascia. Do this to both sides of the vehicle. Set push pins aside to be reinstalled later.



3. Just forward of the front tire, inside the wheel well, remove three (3) push pins. Do this to both sides of the vehicle. Set push pins aside to be reinstalled later.

BX2614
2010-12 Ford Fusion (Includes Hybrid)
2011-12 Lincoln MKZ Hybrid
Installation Instructions

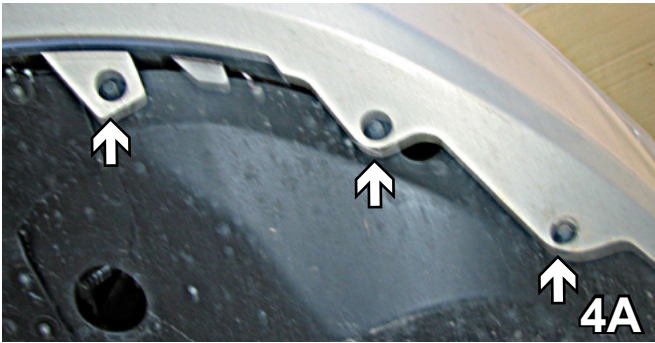

4. **FUSION:** Using a 7MM socket, remove five (5) metric bolts from underneath the front of the fascia.
MKZ: Using a 7MM socket, remove eight (8) metric bolts from underneath the front of the fascia.
Set bolts aside to be reinstalled later.

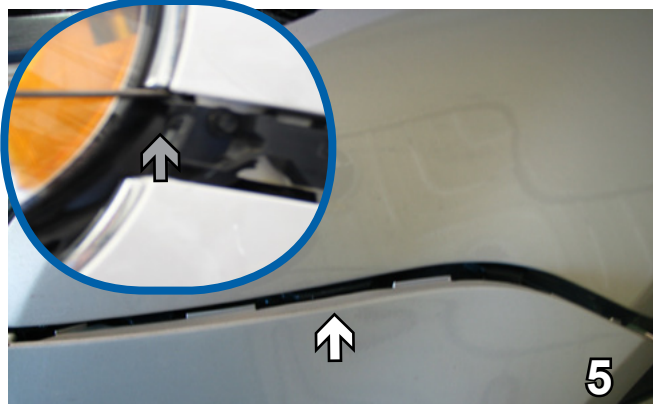

5. **FUSION:** Grab, lift and pull the fascia straight out to remove.
MKZ: Push down on fascia to remove. Using a flat screwdriver, press down on final clip to release (gray arrow) (toward the front by the headlight.) Do this to both sides of the vehicle. Unplug running lights (fog lights). Set fascia aside carefully to be reinstalled later.

6. **FUSION ONLY:** Remove the plastic bumper cover by pushing down on the eight (8) tabs to release. Set the bumper cover aside to be reinstalled later.

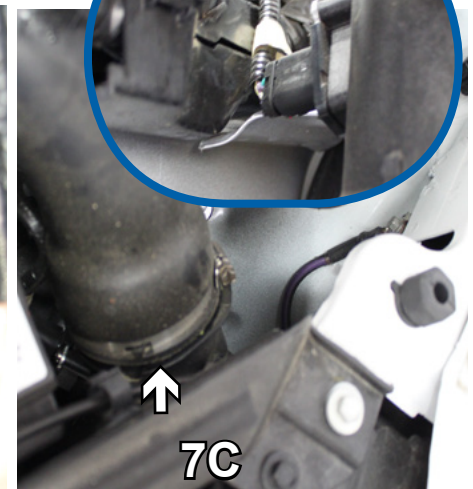
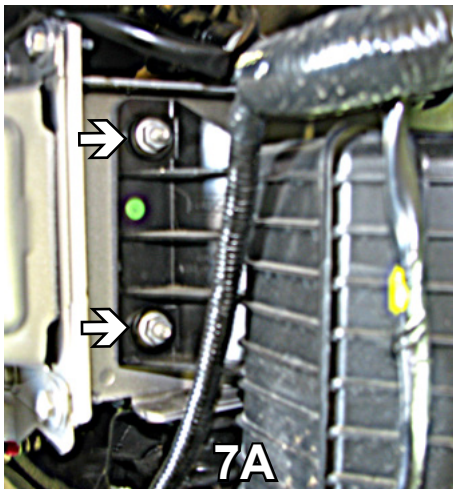

7. On the driver side, using a 13MM socket, remove the three (3) metric bolts from the air baffle, two (2) in the front (7A) and one (1) in the back (7B). **MKZ ONLY:** By the battery, using a flat screw driver, unhook clamp to air baffle and unplug electrical connection (7C). Set the air baffle aside to be reinstalled later.

BX2614
2010-12 Ford Fusion (Includes Hybrid)
2011-12 Lincoln MKZ Hybrid
Installation Instructions

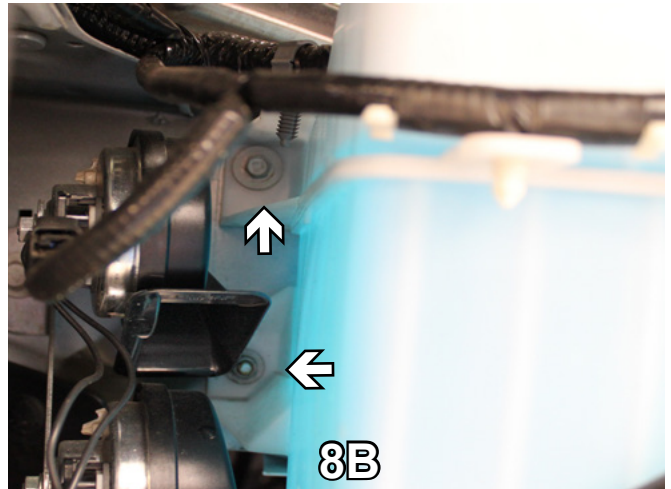
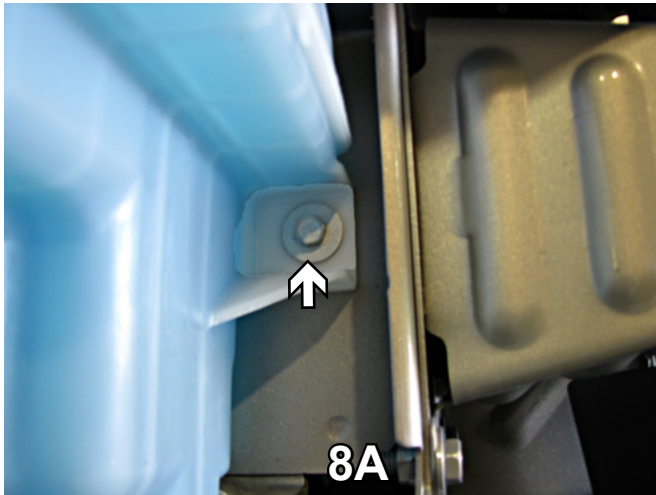

8. On the passenger side using a 10MM socket, remove three (3) metric bolts from the washer reservoir, one (1) on the right side (see 8A) and two (2) on the left (8B). Disconnect the hoses and electrical, plug the hoses. Set washer reservoir and bolts aside to be reinstalled later.

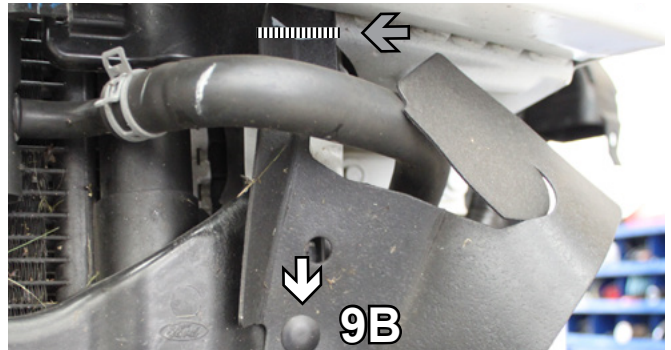

9. **FUSION ONLY:** On the bottom side of the plastic bumper cover, using a utility knife, notch out the corner. Go over 1", then up, across and back. Do this to both sides.

9. **MKZ ONLY:** On the bottom side of the metal bumper, remove one (1) push pin from the bumper guard (white arrow). Using a utility knife, cut bumper guard even with metal bumper and remove (gray arrow). Do this to both sides - the bumper guards will not be reinstalled.

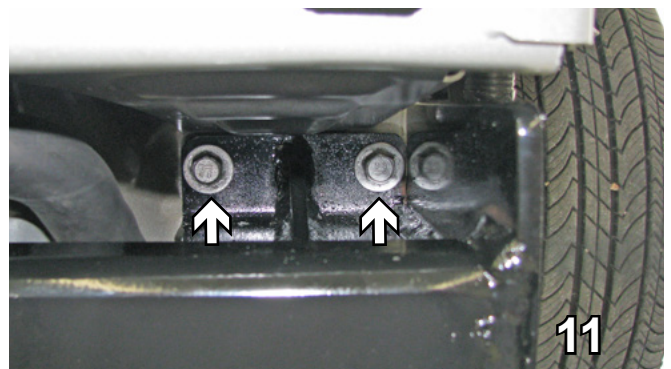
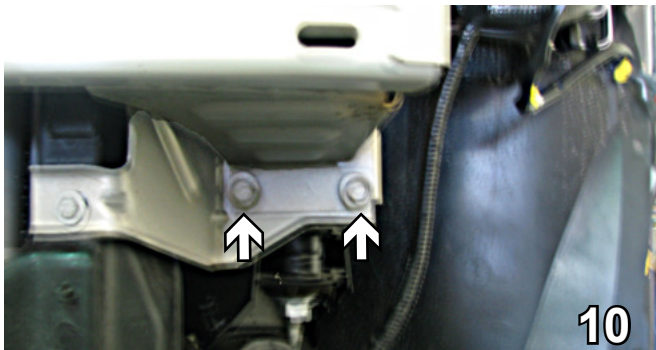

10. Using a 13MM socket, remove two (2) bolts from underneath the bumper. Do this to both sides. Set the bolts aside to be reinstalled later.

11. Slide the baseplate up into place, start the two (92) existing bolts. Do this to both sides of the vehicle.

BX2614
 2010-12 Ford Fusion (Includes Hybrid)
 2011-12 Lincoln MKZ Hybrid
 Installation Instructions

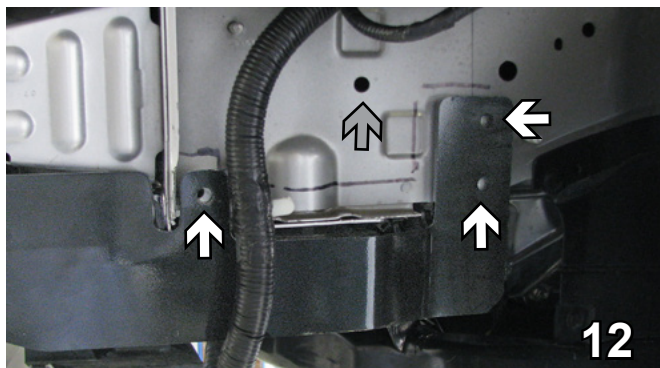

12. Be sure the baseplate is level with respect to the vehicle frame. Using the baseplate as a template with the 13/32" drill bit, drill three (3) holes on the side (white arrows) (make sure baseplate bracket does not bend). Using the 1-1/4" hole saw, drill a hole so that nut plates may be inserted into the frame (gray arrow). Do this to both sides of the vehicle.

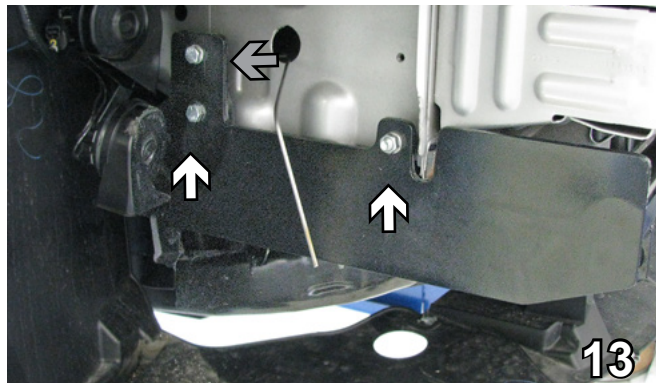

13. On the passenger side, insert 3/8"-16 x 2" hex bolts in all holes, 1" spacers are placed between the baseplate and the frame for each hole. The front hole and the bottom back hole have 3/8" lock washers with 3/8-16 hex nuts (white arrows). The top back hole has the 3/8" lock washer on this side and a 3/8"-16 nut plate inserted into the drilled hole (gray arrow). Be sure to use Loctite Red on all the bolts.

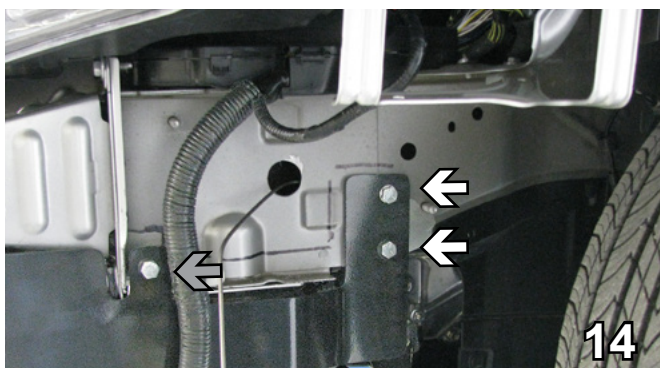

14. On the driver side, insert 3/8"-16 x 2" hex bolt in the front hole (gray arrow), a 1" spacer is placed between the baseplate and the frame, 3/8" lock washer with 3/8"-16 hex nut. The back holes (white arrows) have 3/8-16 x 1-1/2" hex bolts. The bottom back hole has 3/8" lock washer with 3/8"-16 hex nut. The top back hole has the 3/8" lock washer on this side and a 3/8"-16 nut plate inserted into the drilled hole. Be sure to use Loctite Red on all the bolts.



15. On the driver side, trim the corner of the air baffle up to the rubber as shown.

BE SURE TO USE LOCTITE® RED ON ALL BOLTS BEFORE TIGHTENING. TIGHTEN ALL BOLTS ACCORDING TO THE TORQUE CHART ON THE FRONT PAGE OF THESE INSTRUCTIONS OR ON PAGE 3 OF THE BASEPLATE TOWING GENERAL INSTRUCTIONS.

When using power drills be aware of the dangers of torque and drill bit length.

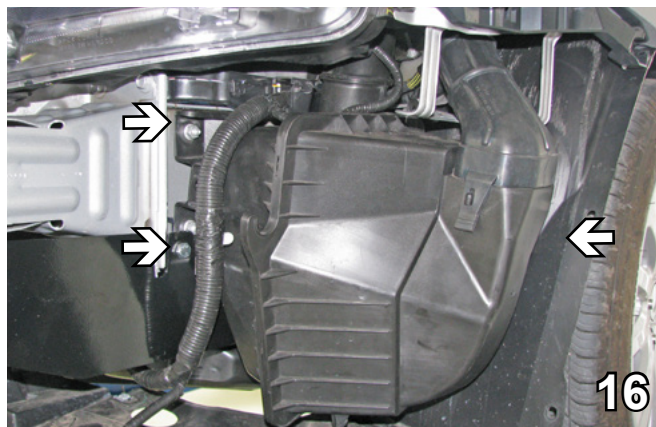

16. Reattach the air baffle and electrical connection. (Photo shown at right)

BX2614
2010-12 Ford Fusion (Includes Hybrid)
2011-12 Lincoln MKZ Hybrid
Installation Instructions

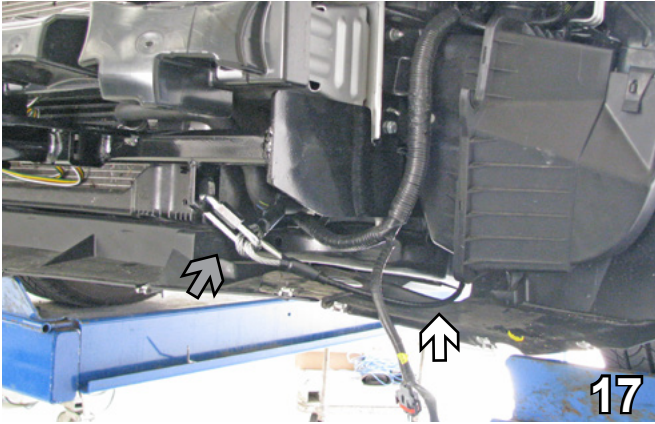

17. Attach the permanent baseplate safety cables to the provided convenience link on the baseplate (gray arrow). The photo to the left shows the recommended installation of the cables to frame of vehicle (white arrow). Additional options may interfere with suggested mounting; in this case, secure the cables to a solid piece of the frame as described in the instructions included with the permanent baseplate safety cables. Be sure the safety cables do not rub against any hoses or moving parts. Do this to both sides of the vehicle.

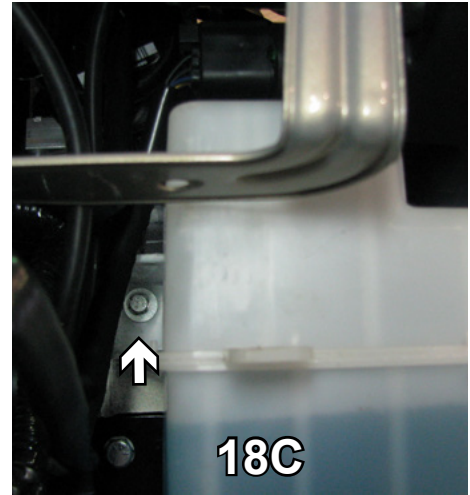

18. Using a utility knife, cut the tab off of the washer reservoir (18A) - Do not cut into the washer reservoir tank because leaking will occur. Reinstall the washer reservoir. Use 6MM-1 x 45MM hex bolts with 6MM lock washers and 1/4" flat washers. Insert 1" spacers between the washer reservoir and the frame for each hole. Reconnect the hoses and the electrical. **FUSION ONLY:** Reinstall the plastic bumper cover. Tighten all bolts completely.

19. **FUSION ONLY:** Using a utility knife, on the back side of the fascia, cut out the first long top rib. Do this to both sides of the fascia. Reinstall the fascia.

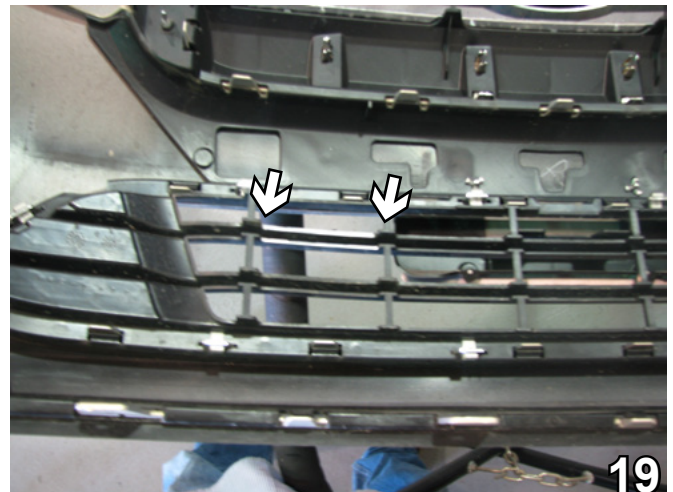

BX2614
2010-12 Ford Fusion (Includes Hybrid)
2011-12 Lincoln MKZ Hybrid
Installation Instructions

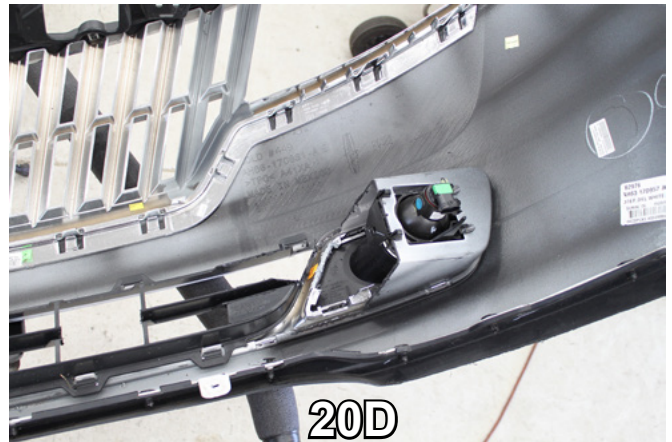
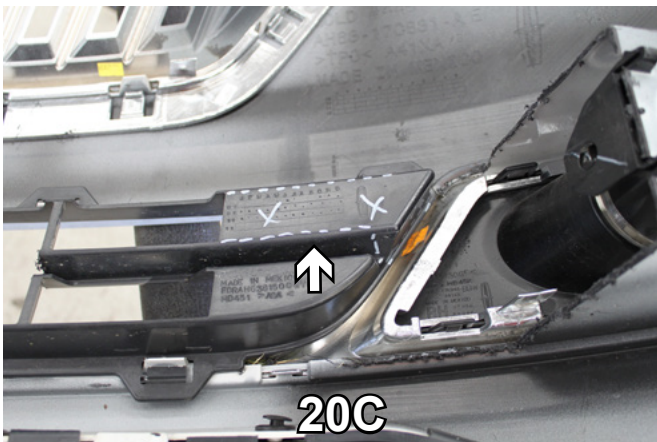
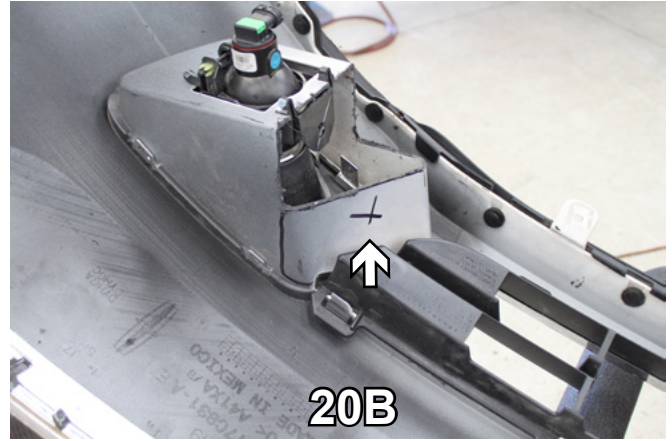
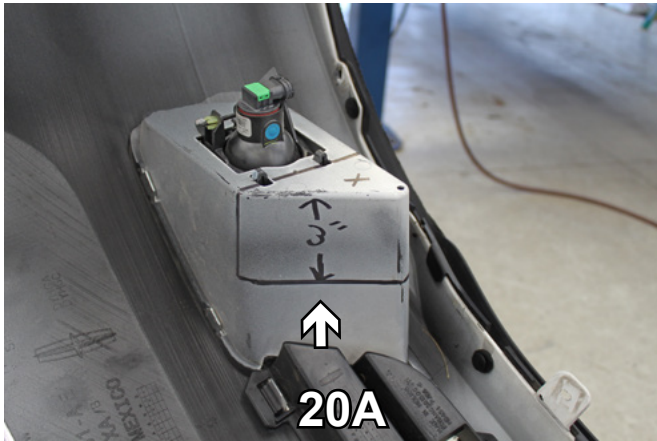

20. **MKZ ONLY:** Using the utility knife, on the back side of the fascia, cut out the fog light enclosure as shown in 20A. Again, using the utility knife, cut the additional piece from the fog light enclosure as shown in 20B. On the inside of the front fascia, trim the area marked in 20C. Do these steps for both sides of the vehicle. A picture is shown in 20D of the completed trimming. Reconnect fog lights and reinstall fascia.

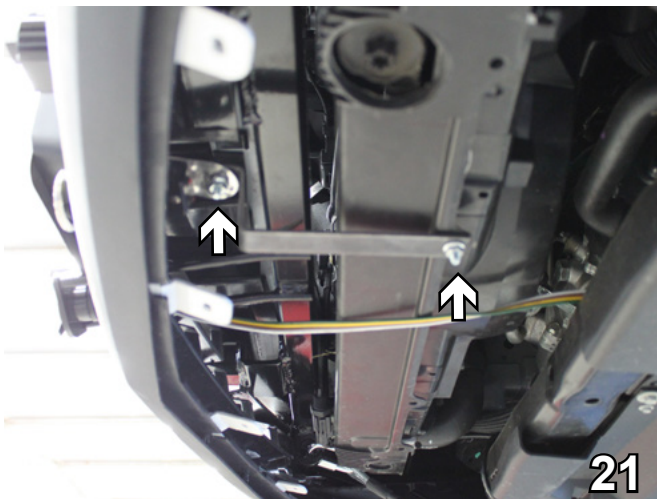

21. **OPTIONAL:** Mount breakaway bracket underneath fascia (as shown in picture to the left). Position it half-way between electrical rods and the convenience link of the baseplate. Install using 1/4"-20 x 3/4" hex bolt, 1/4"-20 hex nylon nut, and #10-16 x 1" drilling screw.

Install the tow bar and safety cables according to the instructions provided in their packages. When demonstrating this to the customer, be sure to include all the contents and packages.

Do **NOT** substitute other devices if the tow bar pins and clips are misplaced.

Be sure that **ALL** electrical connections are plugged in properly and functioning **BEFORE** installing the fascia.

DEALER or INSTALLER:
Be certain the user receives the instruction sheets for their products.

BX2614
2010-12 Ford Fusion (Includes Hybrid)
2011-12 Lincoln MKZ Hybrid
Installation Instructions



FUSION: Shown without removable tabs installed.



FUSION: Shown with removable tabs installed.



MKZ: Shown without removable tabs installed.



MKZ: Shown with removable tabs installed.

CUSTOMER SERVICE COMMITMENT

Blue Ox is committed to providing you with exceptional customer care throughout your lifetime with our products. Our team is here to assist you with any questions you may have regarding the performance of your product. Simply call (402) 385-3051 and you can speak with our customer care team.

Additionally, please visit our website to see which rallies our Destination America team will be attending. For a nominal fee, our service technician will service your towing system to ensure it's in proper working condition. Also, as a commitment to our customers, should you visit our factory, you can stay at our full service Blue Ox campground at no charge along with enjoying a factory tour.

Again, thank you for being our customer and for the confidence you have shown in the performance of our products. It is because of customers like you we enjoy the success we have today.

If the baseplate is in an accident, it must be replaced. DO NOT use it again! An accident can cause unseen damage and using it again could result in more damage or serious injury. DO NOT use the baseplate if it is damaged or missing parts.



© 2011 Blue Ox
One Mill Road, Industrial Park
Pender, Nebraska 68047
Phone: (402) 385-3051 • Fax: (402) 385-3360
www.blueox.com