



Baseplate Installation Instructions

# BX2238 2005-06 Honda CR-V Installation Instructions

**Please read BOTH these Installation Instructions and the General Instructions before attempting to install or operate this equipment.**

Serial Number

- Blue Ox® towing products and accessories are intended to be installed by Blue Ox® Dealers who are familiar with our products and have the equipment necessary and knowledge to do "fit work". When necessary Blue Ox® Dealers can be found at [www.blueox.com](http://www.blueox.com) or by contacting our Customer Care Department at (402) 385-3051.
- Many Blue Ox® Baseplates are designed to use existing holes and hardware to mount the baseplate to the towed vehicle. Even though bolts are there, do not assume they are adequate for baseplate mounting. Always use hardware supplied in the hardware kit and existing hardware specified in the Baseplate Installation Instructions.

Attachment Tab Height: 21"

Attachment Tab Width: 24"

<b>Bolt Torque Specifications</b>		
Torque in Foot-Pounds per Metric Bolts		
Bolt Size	Grade 8.8	Grade 10.9
6MM	6	8
8MM	16	22
10MM	31	40
12MM	54	70
14MM	89	117

**Confirm the towability and pre-towing procedures for your vehicle with the owner's manual or contact the vehicle's manufacturer for specific towing procedures. You can also contact REMCO for additional information at (800)228-2481.**

<b>Bolt Torque Specifications</b>		
Torque in Foot-Pounds per Inch Bolts		
Bolt Size	Grade 5	Grade 8
1/4"	10	14
5/16"	19	29
3/8"	33	47
7/16"	54	78
1/2"	78	119
5/8"	154	230



**If the front of your vehicle looks different than this, call us at (402) 385-3051.**

**! WARNING**

Failure to read and follow these instructions could result in separation of the towed vehicle from the tow bar, causing property damage, loss of towed vehicle, personal injury or death.

# BX2238

## 2005-06 Honda CR-V

### Installation Instructions

#### Parts List

Ref. No.	Qty.	Part #	Description
1	1	61-6076	Weldment, Baseplate, BX2238
2	6	61-5208	3/8" Nutplate, with 14" Wire
3	2	201-0648	3/8-16 x 3/4" Bolt, Grd. 5, ZP
4	4	201-0443	3/8-16 x 1" Bolt, Grd. 5, ZP
5	6	201-0440	3/8-16 x 1 1/2" Bolt, Grd. 5, ZP
6	12	203-0010	3/8" Lock Washer, ZP
7	6	202-0003	3/8-16 Hex Nut, ZP
8	2	201-0553	1/4-20 x 1/2" Hx. Wshd, Type F Screw
9	2	201-0192	#10-32 x 1/2" Slot, Rd. Hd. Screw
10	2	203-0054	#10 Lock Washer
11	2	202-0047	#10-32 Hex Nut
12	2	101-5822	Adapter, 4 Way Connector
13	2	62-3469	Attachment, Assembly, SF/LB (R)
	2	203-0002	5/16" Flat Washer, (Not Shown)
	2	226-0046	Baseplate Safety Cable, 36" CL III (Not Shown)
	2	229-0359	Quicklink 3/8, ZP (Not Shown)
	2	290-0437	Cap Plug, Black (Not Shown)

#### Tools Required

10MM Socket	12MM Socket	13MM Socket
9/16" Socket	5/16" Drill Bit	13/32" Drill
Flat Chisel	Vise Grips	Phillips Screwdriver
LOCTITE Red		

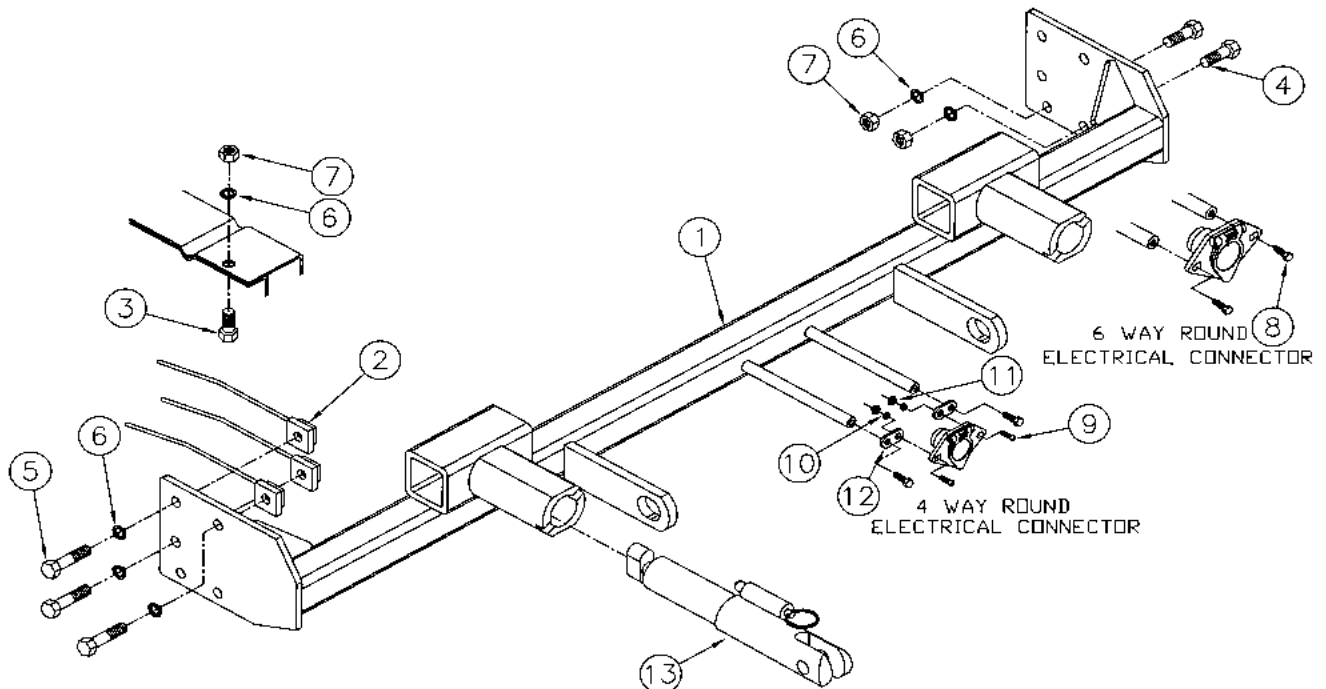

#### Important:

Use only genuine factory replacement parts on your baseplate. Do NOT substitute homemade or non-typical parts. If a bolt is lost or in need of replacement, for your safety and the preservation of your baseplate, be sure to use a replacement bolt of the same grade (In most cases it will be Grade 5, please reference the parts list above). Replacement parts may be ordered through your nearest Blue Ox® Dealer or Distributor, or call our 24/7 Customer Care Team at (402)385-3051.

# BX2238

## 2005-06 Honda CR-V

### Installation Instructions

**Removable Tabs:** Due to the design of the removable tabs, the RangeFinder II tow bar can not be used. Adapters, except for the BX8833 and the BX88151, can not be used with this baseplate.

**Instruction Notes:** The front fascia, horn bracket, and metal bumper are removed and are reinstalled during the baseplate installation. Drilling is required. Some models may require some minor trimming to the back of the fascia. Metal bumper and the passenger's side bumper brace is removed and will not be reinstalled

The dimensional variations between otherwise identical vehicles can be considerable. While the baseplate was designed for easy installation, it may be necessary to tailor the baseplate slightly to compensate for auto manufacturer's tolerances. These minor adjustments may include filing a hole slightly, bending electrical rods, and/ or bending end plates.

The BX8869 Bulb and Socket Wiring Kit is available for this vehicle.

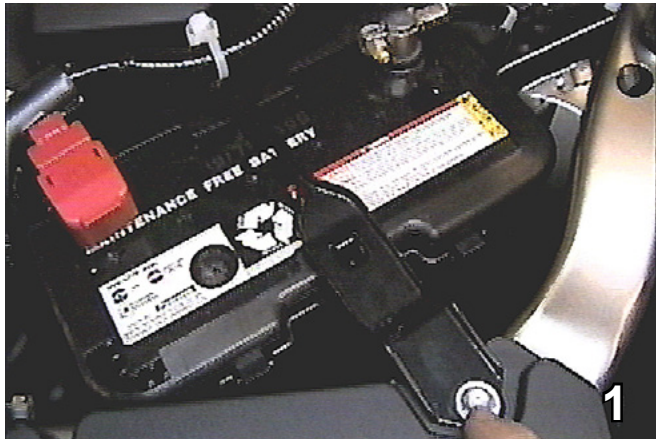

1. Using the 10MM socket, remove the metric bolt from the battery hold down strap. Set the bolt aside to be reinstalled later.

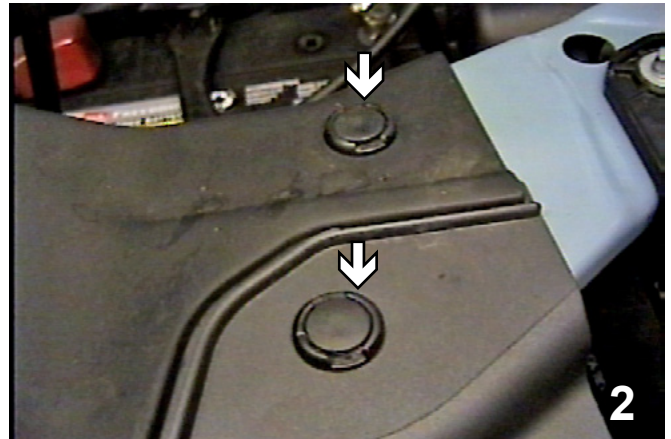

2. Remove NINE pushpins from the top black plastic of fascia. Lift it up to remove. Set the black plastic and pushpins aside to be reinstalled later.



3. Just forward of the front tire use a Phillips screwdriver to remove two Phillips screws. Set the Phillips screws aside to be reinstalled later. Do this to both sides of the vehicle.

# BX2238

## 2005-06 Honda CR-V

### Installation Instructions



4. Remove two pushpins from the bottom edge of the fascia just forward of the front tires. Remove the two pushpins from the lower edge of the fascia just below the license plate bracket, pull fascia corners out to the side to release side clips and then forward. Set the pushpins aside to be reinstalled later. Do this to both sides of the vehicle. **Some models may have a metric bolt to remove from the fascia just forward of the front tire with the 10MM socket, as indicated by the right arrow in the photo above.**

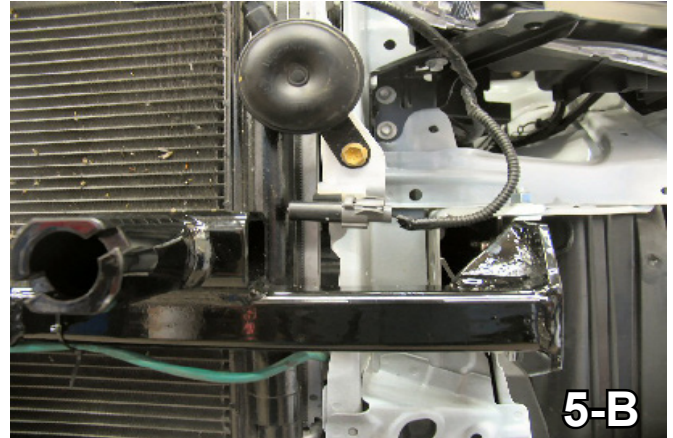
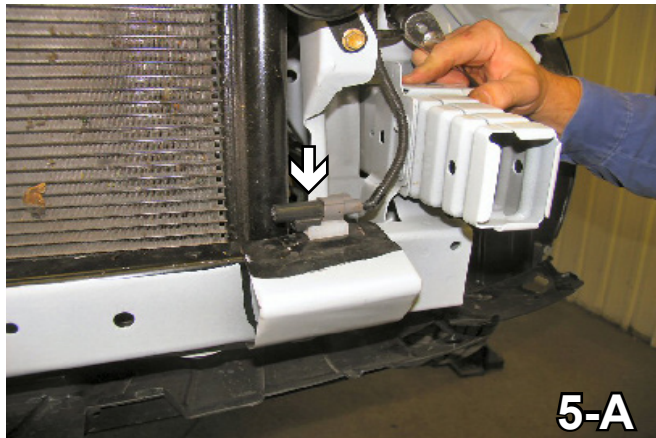

5. Using the 12MM socket, loosen the metric bolt on the horn bracket, disconnect the wire clip on the frame, turn horn bracket toward the radiator. Do this to both sides of the vehicle, then tighten. Be sure that the horn assembly does not touch any other structure. The horn will not work if it is resting on any other object. Release wire clip from temperature sensor bracket on the top side of the metal bumper and first wire clip back on the frame end, set the sensor out of the way. Remove the sensor bracket from the metal bumper, drill a 5/16" hole just below the horn bracket hole, reinstall the sensor bracket and sensor as shown in 5-B.

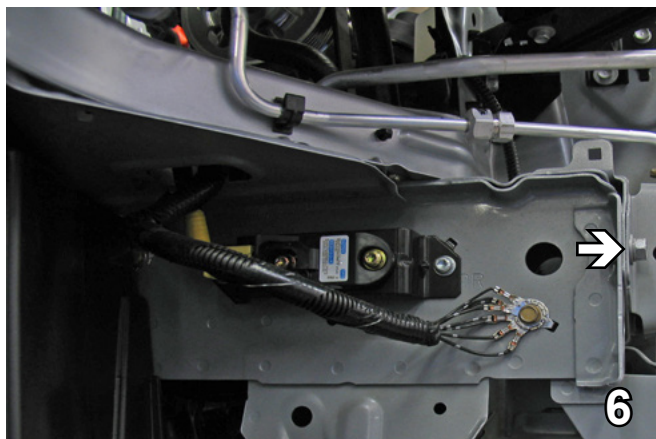

6. Using the 12MM socket, remove one metric bolt from the bumper bracket on the passenger's side, as indicated by the arrow in the photo above. Also remove two metric bolts on the top side of and one metric bolt from the bottom of the bumper bracket and frame. Do this to both sides of the vehicle. Pull the metal bumper forward to remove. The metal bumper will not be reinstalled.

# BX2238

## 2005-06 Honda CR-V

### Installation Instructions

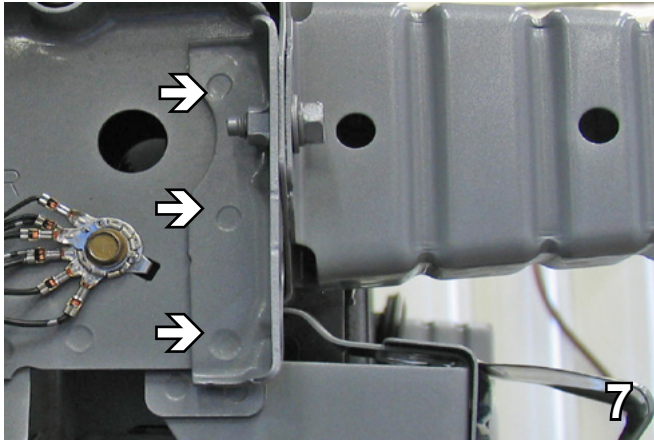

7. To prepare frame for the baseplate installation, drill out the three spot welds on the passenger's side bumper bracket with the 13/32" drill bit. Be careful to ONLY drill through the bumper bracket not the frame. Using the flat chisel and hammer, separate and remove the bumper bracket from the frame.



8. Remove the two christmas tree pushpins from the wheel well cover, just forward of the front tire on the passenger's side and pull cover back to open the front frame area for the baseplate installation. Set the pushpins aside to be reinstalled later. Do this to both sides of the vehicle.

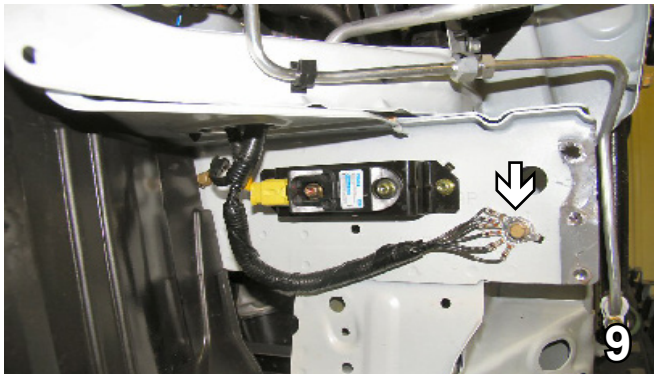

9. Using the 10MM socket, remove the metric bolt to the front ground connection just forward of the air bag sensor on the passenger's side. Set the bolt aside to be reinstalled later.



10. Flatten the locating tab on the side of the front ground connector, relocate to ground connection just behind the air bag sensor on the passenger's side with the 10MM socket and reattach the wheel well to the frame.

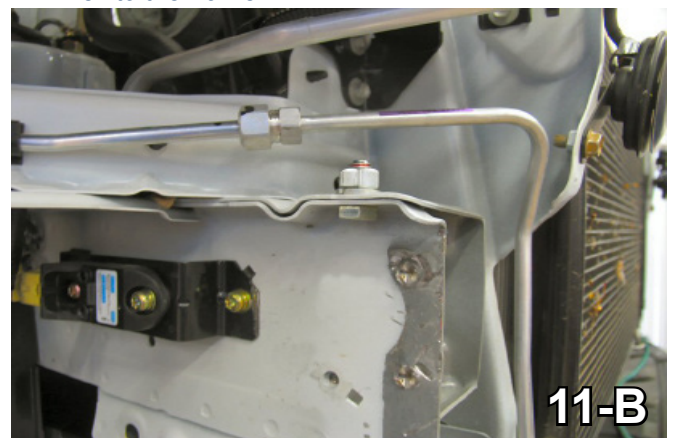

11. Drill a hole in the frame webbing using the 13/32" drill bit. Insert the 3/8-16 x 3/4" hex bolt into the bottom side of the drilled hole, tighten lock washer and hex nut. Do this to both sides of the vehicle.

# BX2238

## 2005-06 Honda CR-V

### Installation Instructions

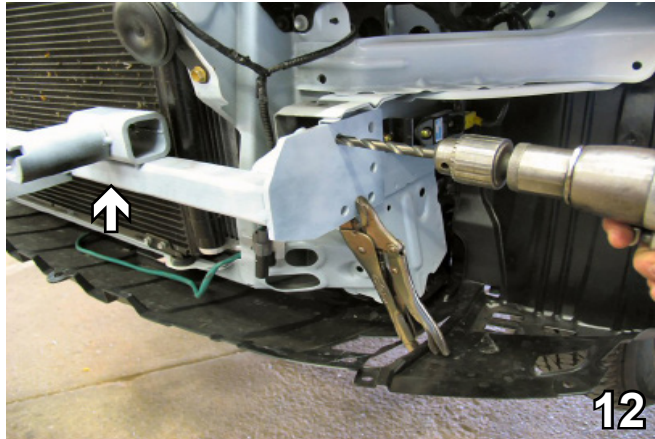

12. Slide the baseplate end plate onto the frame rail to align level with the bottom edge of the frame and clamp into place with the vise grips. Be sure attachment tab receiver is on top of cross tube, see the arrow in the photo above. Slide the fascia onto the vehicle to its original position to verify the proper fit of the baseplate. Remove fascia and drill all holes with the 13/32" drill bit using the baseplate as a template. Do this to both sides of the vehicle.



13. Insert the nut plates into the end of the frame rail to align with the three top drilled holes, tighten the 3/8-16 x 1 1/2" hex bolt and lock washer, as shown in 13-A. Insert the 3/8-16 x 1" hex bolts into the two bottom holes of the baseplate. Tighten the 3/8" hex nut and lock washer. Do this to both sides of the vehicle, 13-B shows when this has been completed.

14. Reinstall the fascia. Remove the pushpins on the back edge of the belly pan and place the 5/16" flat washers on the back side of the fascia and belly pan for the two middle push pins on the lower edge of the fascia.

**BE SURE TO USE LOCTITE® RED ON ALL BOLTS BEFORE TIGHTENING. TIGHTEN ALL BOLTS ACCORDING TO THE TORQUE CHART ON THE FRONT PAGE OF THESE INSTRUCTIONS OR ON PAGE 3 OF THE BASEPLATE TOWING GENERAL INSTRUCTIONS.**

**Do not use the towed vehicle for storing luggage, equipment, etc. This may cause you to exceed the towing capacity of the tow bar, baseplate, and its accessories.**

Be sure that **ALL** electrical connections are plugged in properly and functioning **BEFORE** Installing the fascia.

# BX2238

## 2005-06 Honda CR-V

### Installation Instructions

Install the tow bar and safety cables according to the instructions included in their packages.

Do not substitute other devices if the tow bar pin and clip are lost.

#### **DEALER or INSTALLER:**

**Be certain the user receives the instruction sheets for their products.**



**Possible location for the Bulb and Socket Wiring Kit (BX8869)**



**Shown with removable tabs installed**

#### **CUSTOMER SERVICE COMMITMENT**

Blue Ox is committed to providing you with exceptional customer care throughout your lifetime with our products. Our team is here to assist you with any questions you may have regarding the performance of your product. Simply call 1-800-228-9289 and you can speak with our customer care team.

Additionally, please visit our website to see which rallies our Destination America team will be attending. For a nominal fee, our service technician will service your towing system to ensure it's in proper working condition. Also, as a commitment to our customers, should you visit our factory, you can stay at our full service Blue Ox campground at no charge along with enjoying a factory tour.

Again, thank you for being our customer and for the confidence you have shown in the performance of our products. It is because of customers like you we enjoy the success we have today.



© 2011 Blue Ox  
One Mill Road, Industrial Park  
Pender, Nebraska 68047  
Phone: (402) 385-3051  
Fax: (402) 385-3360  
[www.blueox.com](http://www.blueox.com)