



**BLUE OX**<sup>®</sup>

## BX1742

2016-2019 Chevy Silverado 1500 (Old Style)  
2016-2019 GMC Sierra 1500 Classic (Includes Denali)  
2016-2020 Chevy Suburban Z71 (No ACC)  
2016-2020 Chevy Tahoe Z71 (No ACC)

### Installation Instructions

Please read **BOTH** these Installation Instructions and the General Information prior to installing or operating this equipment.



Attachment Tab Height: 18"

Attachment Tab Width: 32-1/2"

Serial Number

1. Blue Ox<sup>®</sup> towing products and accessories are intended to be installed by Blue Ox<sup>®</sup> Dealers who are familiar with our products and have the equipment and knowledge necessary to do "fit work". If needed, Blue Ox<sup>®</sup> Dealers can be found at [www.blueox.com](http://www.blueox.com) or by contacting our Technical Service Department at (402) 385-3051.
2. Many Blue Ox<sup>®</sup> baseplates are designed to use existing holes and hardware to mount the baseplate to the towed vehicle. Even though bolts are there, do not assume they are adequate for baseplate mounting. Always use the hardware supplied in the hardware kit and existing hardware as specified in the installation instructions.



If the front of your vehicle looks different than these, please contact us at (402) 385-3051.

## WARNING

Failure to read and follow these instructions could result in separation of the towed vehicle from the tow bar, causing property damage, loss of towed vehicle, personal injury or death.

Reference your vehicle owner's manual for manufacturer's towing specifications.

# BX1742

2016-2019 Chevy Silverado 1500 (Old Style)  
2016-2019 GMC Sierra 1500 Classic (Includes Denali)  
2016-2020 Chevy Tahoe Z71 / Suburban Z71 (No ACC)

## Installation Instructions

**Instruction Notes:** The fascia, shroud cover and bumper are removed and reinstalled for the baseplate installation. Some drilling and trimming is required.

Place all components that are removed on a flat, sturdy surface. All items will be reinstalled unless otherwise noted after the baseplate is installed.

The dimensional variations between otherwise identical vehicles can be considerable. While the baseplate was designed for easy installation, it may be necessary to tailor the baseplate slightly to compensate for vehicle manufacturer's tolerances.

The BX8848 4-Diode Wiring Kit is recommended Silverado 1500/Sierra 1500 vehicles.

The BX8869 Tail Light Wiring Kit is recommended Tahoe Z71/Suburban Z71 vehicles.

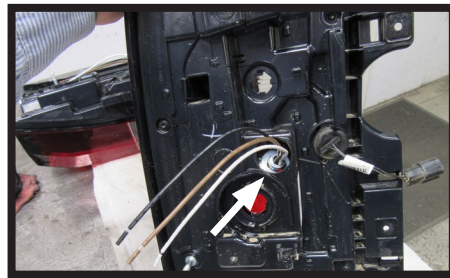

Drill a hole according to the tail light wiring kit instructions.

### NOTICE

- Handling of some cosmetic parts when installing this product may require the use of protective covers, rags, specialty tools, etc. to prevent damage.
- When using power drills be aware of the dangers of torque and drill bit length.
- When using a reciprocating saw be aware of objects behind the cutting surface.
- Use a good quality paint to spray cut edges of frame to prevent rusting.
- Be sure that **ALL** electrical connections are plugged in and accessories are functioning properly before reinstalling the fascia.
- The baseplate is computer tested to your vehicle's GVWR, exceeding this weight will void the manufacturer's warranty.
- Be sure to use a sufficient amount of Loctite® Red on all bolt threads before tightening. Tighten all bolts according to the torque chart provided.
- Dealer or installer be certain the user receives these instruction sheets.
- If the baseplate is in an accident, it must be replaced. **DO NOT** use it again! An accident can cause unseen damage and using it again could result in more damage or serious injury. **DO NOT** use the baseplate if it is damaged or missing parts.

Bolt Torque Specifications		
Torque in Foot-Pounds for Inch Bolts		
Bolt Size	Grade 5	Grade 8
1/4"	10	14
5/16"	19	29
3/8"	33	47
7/16"	54	78
1/2"	78	119
5/8"	154	230
3/4"	257	380

Bolt Torque Specifications		
Torque in Foot-Pounds for Metric Bolts		
Bolt Size	Grade 8.8	Grade 10.9
6MM	6	8
8MM	16	22
10MM	31	40
12MM	54	70
14MM	89	117
16MM	161	230
18MM	222	318

# BX1742

2016-2019 Chevy Silverado 1500 (Old Style)  
 2016-2019 GMC Sierra 1500 Classic (Includes Denali)  
 2016-2020 Chevy Tahoe Z71 / Suburban Z71 (No ACC)  
**Installation Instructions**

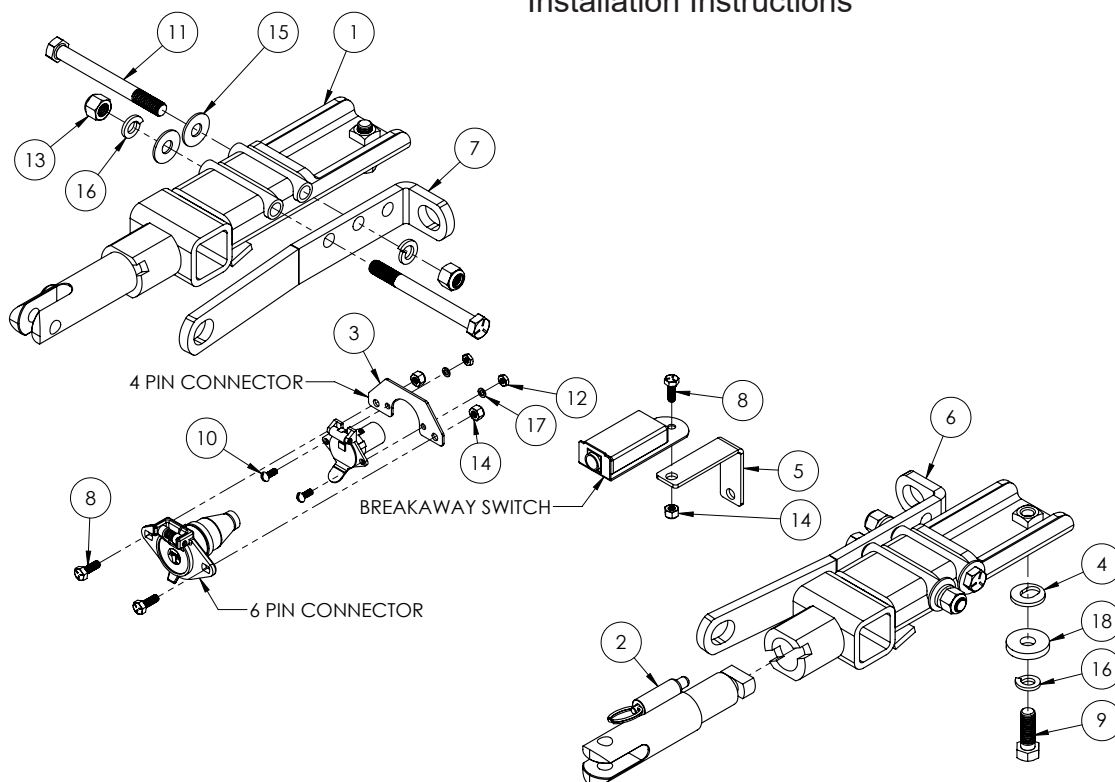

## Tools Required

Large Vise Grip  
 Flat Screwdriver  
 Torque Wrench  
 Drill  
 Tape Measure  
 Loctite® RED  
 1/2" Drill Bit  
 7MM Socket  
 10MM Socket  
 15MM Socket  
 18MM Socket  
 18MM Wrench  
 7/16" Socket  
 7/16" Wrench  
 3/4" Socket  
 3/4" Wrench  
 5/16" Nut Driver  
 1-1/4" Hole Saw

Item No.	Part No.	Description	Qty.
1.....	61-8330 .....	BX1742 Baseplate.....	2
2.....	62-3468 .....	Attachment Tab Assembly with Hole .....	2
3.....	101-7756 .....	4-Way Bracket.....	1
4.....	101-10365.....	10 GA Sleeve with Slot Plate.....	2
5.....	102-7287 .....	Breakaway Bracket .....	1
6.....	102-7480.....	Convenience Link, DS.....	1
7.....	102-7481.....	Convenience Link, PS.....	1
8.....	201-0050.....	1/4"-20 x 3/4" Hex Head Bolt, Grade 5, ZP .....	3
9.....	201-0051.....	1/2"-13 x 1-1/2" Hex Head Bolt, Grade 5.....	2
10.....	201-0192.....	#10-32 1/2" Round Slotted Head Screw.....	2
11.....	201-0786.....	1/2"-13 x 5" Hex Head Bolt, Grade 5, ZP .....	4
12.....	202-0047 .....	#10-32 Hex Nut .....	2
13.....	202-0094.....	1/2"-13 Hex Nylon Insert Lock Nut, ZP.....	4
14.....	202-0102.....	1/4"-20 Hex Nylon Nut, ZP .....	3
15.....	203-0004.....	7/16" Flat Washer, ZP.....	4
16.....	203-0012.....	1/2" Lock Washer, ZP .....	6
17.....	203-0054 .....	#10 Lock Washer, ZP .....	2
18.....	203-0127 .....	1-1/2" OD x 17/32" ID x 1/4" Thick Washer .....	2
19.....	226-0049(not shown).....	Class IV Safety Cables.....	2
20.....	229-0512(not shown).....	1/2" Quicklink, ZP .....	2
21.....	290-0437(not shown).....	Black Cap Plug Receiver.....	2

### Important:

Use only genuine factory replacement parts on your baseplate. Do **NOT** substitute homemade or non-typical parts. If a bolt is lost or in need of replacement, for your safety and the preservation of your baseplate, be sure to use a replacement bolt of the same grade (In most cases it will be Grade 5, please reference the parts list above). Replacement parts may be ordered through your nearest Blue Ox® Dealer or Distributor. Failing to follow and/or altering these installation instructions in either installation or required equipment will void the manufacturer's warranty. Towing behind a non-motorized vehicle will void the warranty.



## BX1742

2016-2019 Chevy Silverado 1500 (Old Style)  
2016-2019 GMC Sierra 1500 Classic (Includes Denali)  
2016-2020 Chevy Tahoe Z71 / Suburban Z71 (No ACC)  
Installation Instructions

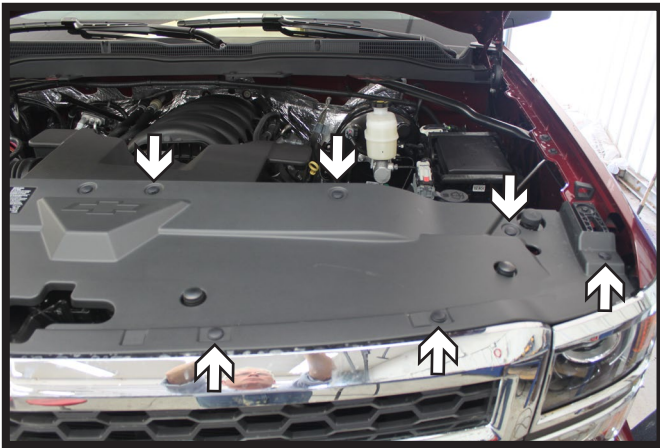

1. **All Models:** Remove the twelve (12) push pins from the shroud cover. There are six (6) on each side. Set the cover aside.

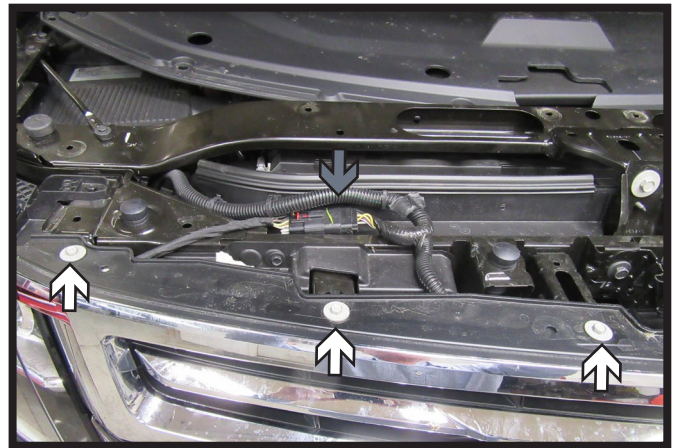

- 2a. **All Tahoe/Suburban Models:** Using a 10MM socket, remove the six (6) screws from the top edge of the fascia (white). There are three (3) on each side. On the passenger side, disconnect the wiring harness (gray).

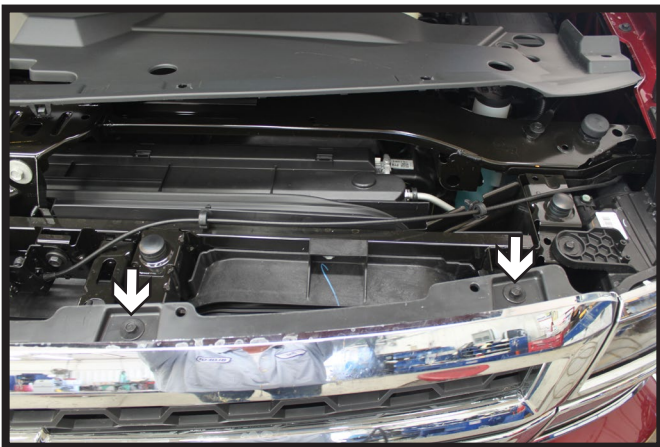

- 2b. **All Silverado/Sierra Models:** Using a 10MM socket, remove the four (4) screws from the top edge of the grille. There are two (2) on each side.



- 3a. **All Tahoe/Suburban Models:** Using a 7MM socket, remove the screws from the edge of the wheel well. Do this on both sides of the vehicle. Quantity of screws vary per model.

## BX1742

2016-2019 Chevy Silverado 1500 (Old Style)  
2016-2019 GMC Sierra 1500 Classic (Includes Denali)  
2016-2020 Chevy Tahoe Z71 / Suburban Z71 (No ACC)  
Installation Instructions

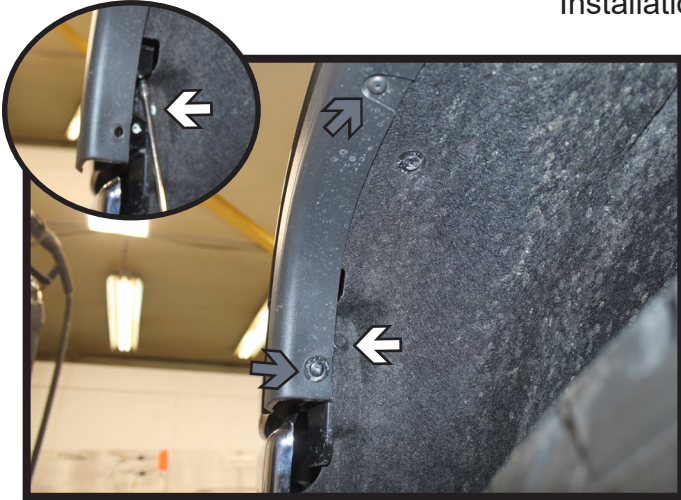

- 3b. **Sierra 1500 Models:** Using a 7MM socket, remove the screw from the wheel well (white). Using a T15 Torx, remove the screws (gray). Pull out the fender flare, then using a 7MM socket with extension if needed, remove the screw from the wheel well (inset). Do this on both sides of the vehicle.

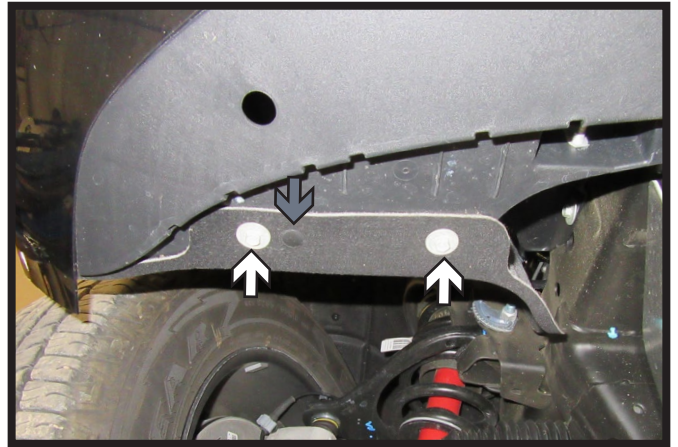

4. **All Tahoe/Suburban Models:** Using a 10MM socket, remove the six (6) screws from the underside of the fascia. There are three (3) on each side. Remove the two (2) push pins located in front of the tires (gray).

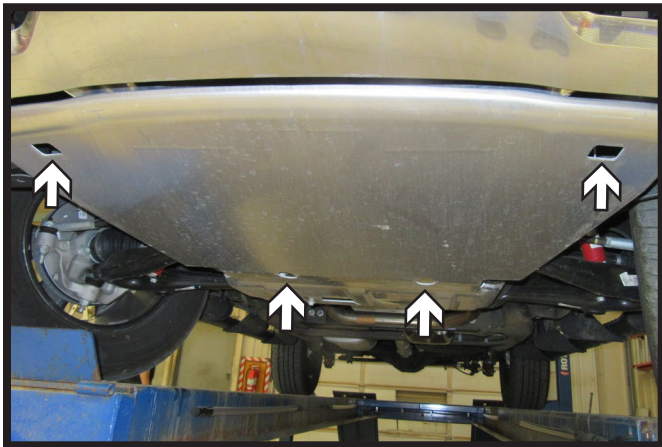

5. **All Z71 Models:** Using a 16 MM socket remove the four (4) bolts, two (2) in the front and back, attaching the belly pan.



6. **All Tahoe/Suburban Models:** Using a 10MM socket, remove the two (2) remaining screws from the underside of the fascia.



## BX1742

2016-2019 Chevy Silverado 1500 (Old Style)  
2016-2019 GMC Sierra 1500 Classic (Includes Denali)  
2016-2020 Chevy Tahoe Z71 / Suburban Z71 (No ACC)  
Installation Instructions



7a. **All Tahoe/Suburban Models:** Gently pry the clips of the corners of the fascia loose from the fender. Behind the grille towards the base, pop loose the two (2) clips. Remove the fascia from the vehicle and set aside.



7b. **Sierra 1500 Models:** Unsnap the six (6) tabs from the backside of the fascia. Remove the fascia from the vehicle and set aside.

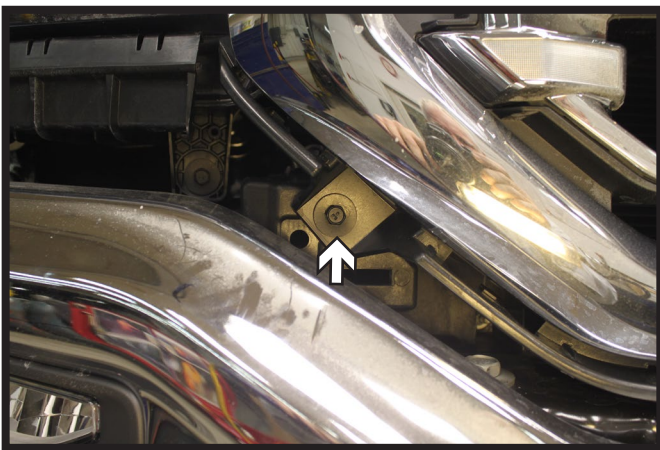

8. **All Sierra 1500 Models:** Using a 10MM socket, remove the four (4) screws from the bottom edge of the grille. There are two (2) on each side and set the grill aside (left).

**All Silverado 1500 Models:** Unsnap the eight (8) clips from the backside of the grille and set the grille aside (right).

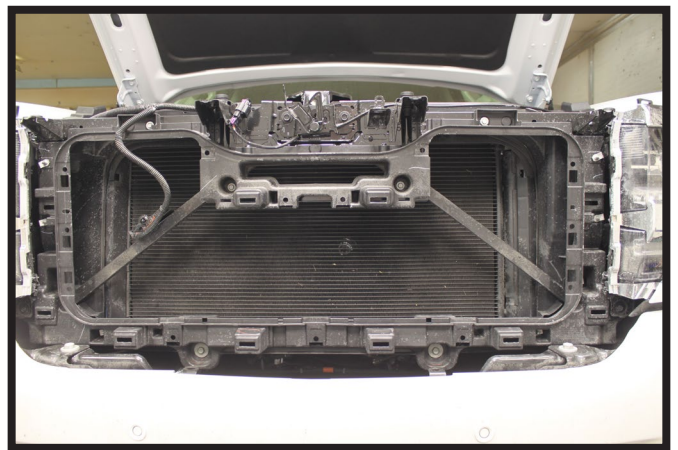

## BX1742

2016-2019 Chevy Silverado 1500 (Old Style)  
2016-2019 GMC Sierra 1500 Classic (Includes Denali)  
2016-2020 Chevy Tahoe Z71 / Suburban Z71 (No ACC)  
Installation Instructions



9. **All Silverado/Sierra Models:** Using a 15MM socket, remove the bolt from the bumper reinforcement bar. Do this on both sides of the vehicle. Disconnect the running lights/electrical connections (gray).

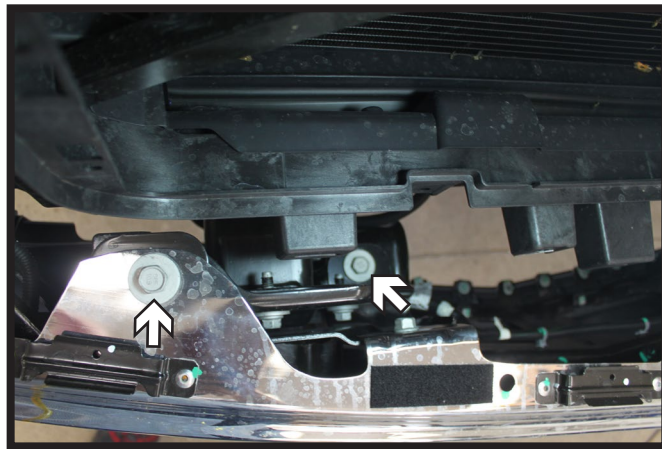

10. **All Silverado/Sierra Models:** Using a 18MM socket, remove the four (4) bolts from the top of the bumper. There are two (2) on each side. Set the bumper aside.

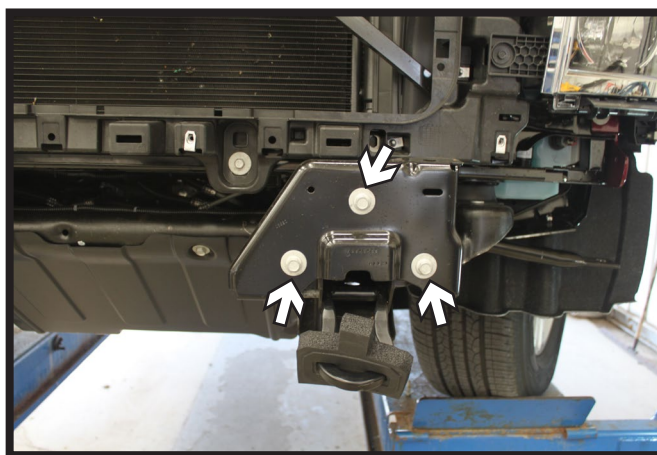

11. **All Silverado/Sierra Models:** Using a 15MM socket, remove the three (3) bolts from the cover plate. Do this on both sides of the vehicle.



## BX1742

2016-2019 Chevy Silverado 1500 (Old Style)  
2016-2019 GMC Sierra 1500 Classic (Includes Denali)  
2016-2020 Chevy Tahoe Z71 / Suburban Z71 (No ACC)  
Installation Instructions

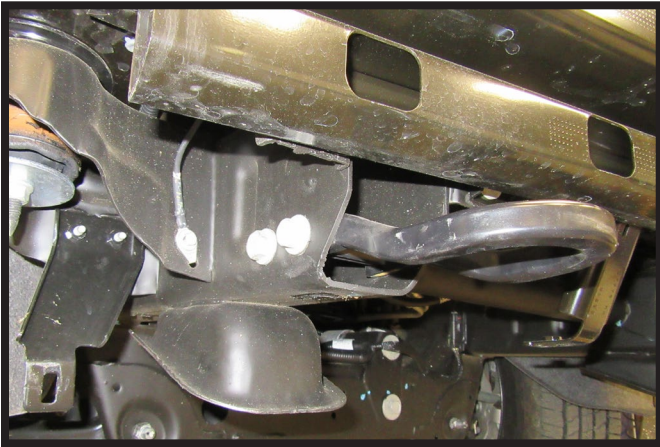

12a. **All Tahoe/Suburban Models:** Using a 18MM socket remove the six (6) bolts, three (3) on each side, attaching the tow hooks and remove tow hooks. Do this on both sides of the vehicle.

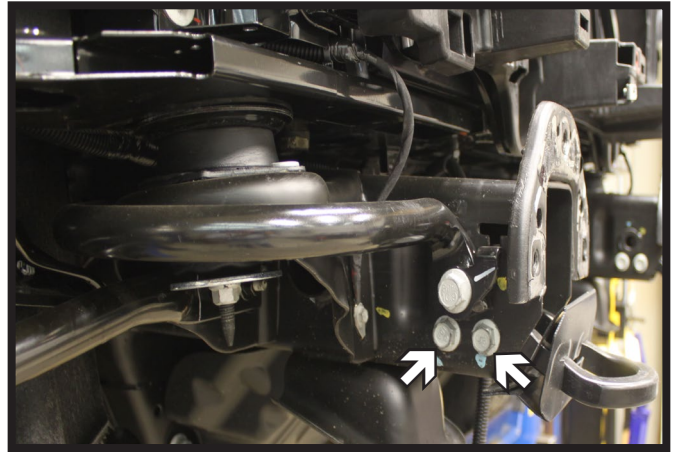

12b. **All Silverado/Sierra Models:** Using a 18MM socket/wrench, remove the two (2) bolts from the tow hook. Do this on both sides of the vehicle (left). Set the tow hooks and hardware aside they will not be reinstalled.



13. **All Models:** Slide the baseplate into place. If the baseplate does not slide in, tap the edges of the housing outward slightly. Do this on both sides of the vehicle.



## BX1742

2016-2019 Chevy Silverado 1500 (Old Style)  
2016-2019 GMC Sierra 1500 Classic (Includes Denali)  
2016-2020 Chevy Tahoe Z71 / Suburban Z71 (No ACC)  
Installation Instructions

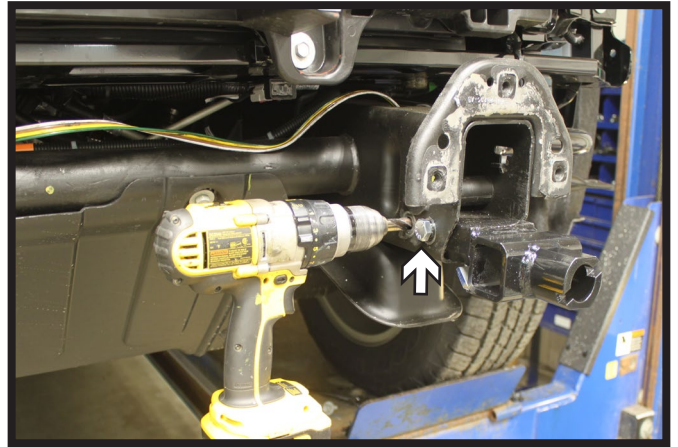
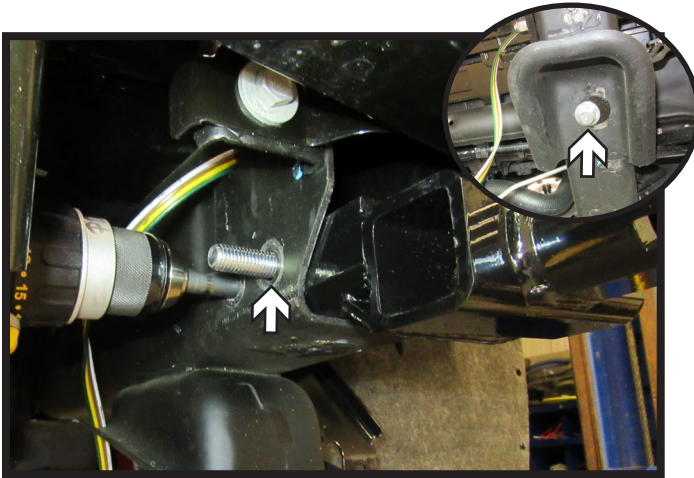

14. **All Models:** Insert the front 1/2" bolt and start the bottom 1/2" bolt with slotted plate and 1/4" thick washer, do this on both sides of the vehicle. Do not fully tighten the bolts.  
**Note:** The bottom frame hole may need to be reamed out to align with the slot.

Using the baseplate as a template, use a 1/2" drill bit to drill the second hole. For the driver side drill hole drill from the inside and for the passenger side drill from the outside.

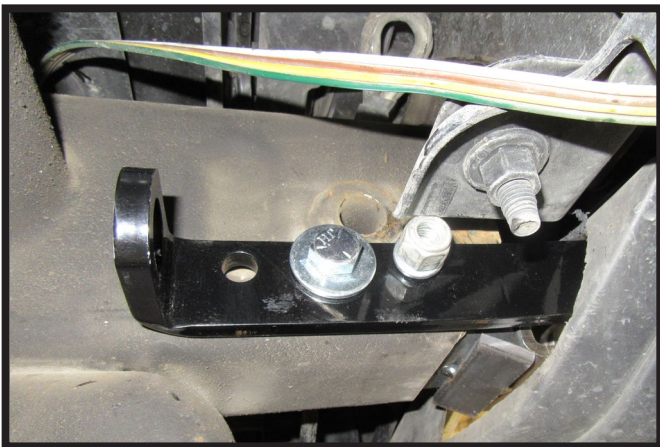

15. **All Models:** Remove the front bolt and then line up the convenience link on the inside of the frame. Insert both 1/2" bolts in opposite directions with washer and nylon lock nut and tighten fully. Tighten the bottom bolt at this time. Do this for both sides of the vehicle.  
**Note:** Start by attaching convenience link using the front two (2) holes. If more fascia clearance is needed use back two (2) holes.

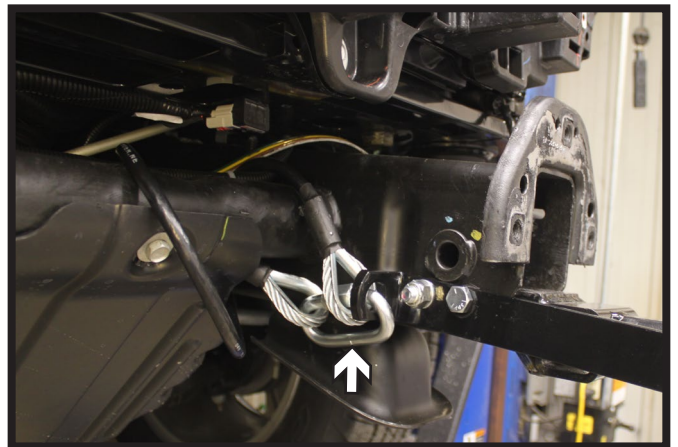

16. **All Models:** Attach the permanent baseplate safety cables to the provided convenience link on the baseplate. The photo above shows the recommended installation of the cables to frame of vehicle. Additional options may interfere with suggested mounting; in this case, secure the cables to a solid piece of the frame as described in the General Information sheet. Be sure the safety cables do not rub against any hoses or moving parts. Do this on **BOTH** sides of the vehicle.

## BX1742

2016-2019 Chevy Silverado 1500 (Old Style)  
2016-2019 GMC Sierra 1500 Classic (Includes Denali)  
2016-2020 Chevy Tahoe Z71 / Suburban Z71 (No ACC)  
Installation Instructions



17a. **All Tahoe/Suburban Models:** On the inside of the fascia trim the indicated area to allow the attachment tabs and convenience links to fit through. Do this on both sides of the fascia.

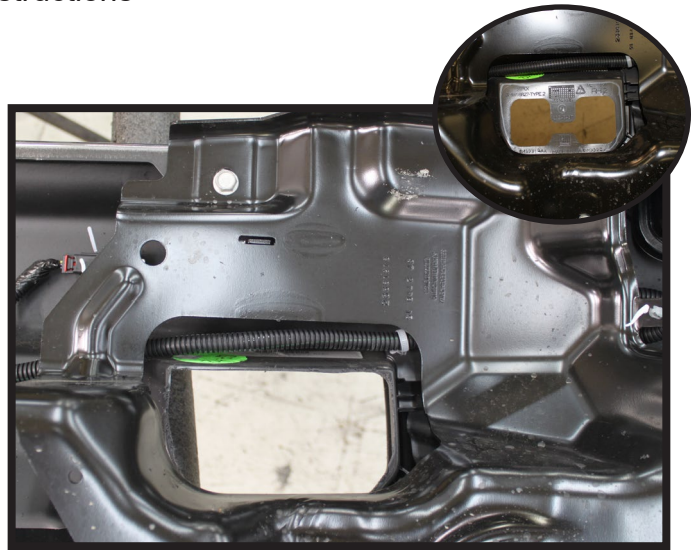

17b. **All Silverado/Sierra Models:** Trim out the tow hook pocket opening to fit around the baseplates.

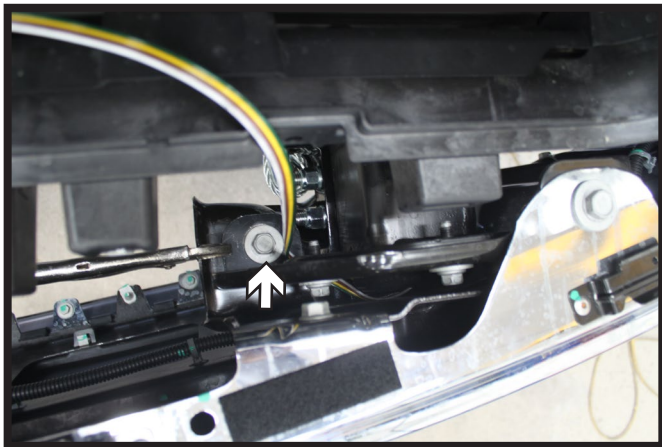

18. **All Silverado/Sierra Models:** Reinstall the cover plates and bumper onto the vehicle. Install the top outer bolts, then push in on the bottom of the bumper to line up the inner bottom bolts. Clamp the bumper when the hole is lined up and reinstall the lower bolts. Continue to reinstall the bumper bar bolts and reconnecting the electrical connections on the underside of the bumper.

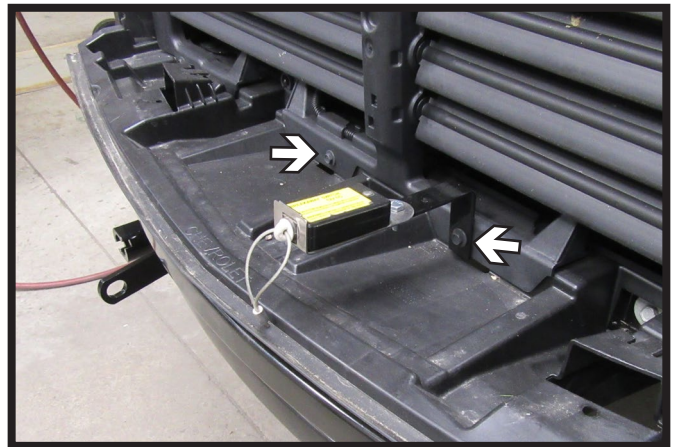

19. **Optional Tahoe/Suburban Models:** Using either existing bolt attach the brakeaway bracket. Then use a 1/4" bolt to attach the brakeaway switch to the bracket.



## BX1742

2016-2019 Chevy Silverado 1500 (Old Style)  
2016-2019 GMC Sierra 1500 Classic (Includes Denali)  
2016-2020 Chevy Tahoe Z71 / Suburban Z71 (No ACC)  
Installation Instructions



20. **Optional Silverado/Sierra Models:**  
Prior to fully reinstalling the fascia. Drill a hole thru the bumper at the desired location to accommodate the plug and bolts. Using 1/4" x 1-1/2" bolts with 1/4" washers, install the plug thru the bumper. On the backside of the bumper, install the electrical bracket and 1/4" locknuts to secure the plug to the bumper.



21. **All Models:** Reinstall the grille, fascia and shroud cover.

**Note:** For Z71 Models reinstall belly pan as well.

## CUSTOMER SERVICE COMMITMENT

Blue Ox® is committed to providing you with exceptional customer care throughout your lifetime with our products. Our team is here to assist you with any questions you may have regarding the performance of your product. Simply call (402) 385-3051 and you can speak with our customer care team.

Additionally, please visit our website to see which rallies our Destination America team will be attending. For a nominal fee, our service technician will service your towing system to ensure it's in proper working condition. Also, as a commitment to our customers, should you visit our factory, you can stay at our full service Blue Ox® campground at no charge along with enjoying a factory tour.

Again, thank you for being our customer and for the confidence you have shown in the performance of our products. It is because of customers like you we enjoy the success we have today.

© 2016 Blue Ox  
One Mill Road, Industrial Park  
Pender, Nebraska 68047  
Phone: (402) 385-3051  
Fax: (402) 385-3360  
[www.blueox.com](http://www.blueox.com)

# General Information

1. Ensure that your product(s) are registered online at [www.blueox.com](http://www.blueox.com). It is crucial to register your product(s) so that you may be alerted of product offerings, updates, upgrades, maintenance and safety bulletins, and/or recalls.
2. **It is the owner's responsibility to inspect all towing equipment for cracked welds, missing or worn parts and loose bolts before each towing trip.** Be sure to use Loctite® Red on all bolts and tighten to the recommended specifications.
3. **It is the owner's responsibility to hook up all towing equipment per manufacturer's instructions/recommendations.**
4. Remove the attachment tabs when not in use (if applicable).

## Notice To Baseplate Installer

### 1. It is YOUR responsibility to watch for:

- Oil cooler and air conditioner lines
- Electrical wires and hoses
- Missing parts or attaching points on the frame

\*\* If the baseplate is improperly installed and is against a wire or hose, it could cause fluid leaks or electrical shorts some time after the actual baseplate installation.

## Permanent Baseplate Safety Cable Installation

Permanent baseplate safety cables are strongly recommended when towing a vehicle with a tow bar. The principle function of the permanent baseplate safety cables is to prevent the towed vehicle from breaking loose in the event the connection between the frame of the towed vehicle and the baseplate fails or becomes disconnected. The cables must be connected from the baseplate to the frame rail or cross member of the vehicle's frame. The illustrations below show the possible arrangements recommended by Blue Ox®. Each permanent baseplate safety cable must have an adequate weight rating for the towing system. The weight rating of the two (2) cables together will not qualify.

***Do not mount the permanent baseplate safety cables against wires, hoses or brake lines.***

These permanent baseplate safety cables should remain installed as long as the baseplate is installed on the vehicle. Permanent baseplate safety cables are to be used in conjunction with, and NOT a replacement for legally required safety cables attaching the towed vehicle to the towing vehicle.

### Option #1

(Baseplates with Convenience Link Tabs)

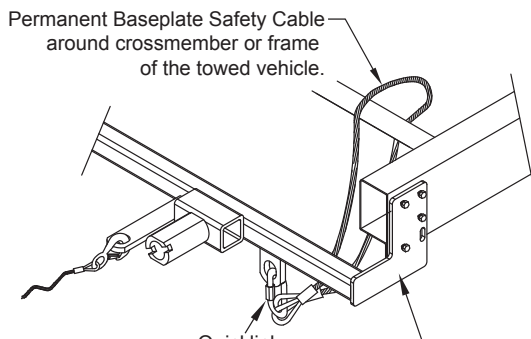

### Option #2

(Baseplates with out Convenience Link Tabs)

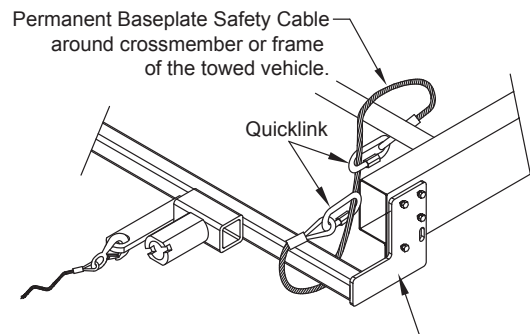



# BLUE OX ORIGINAL PURCHASERS THREE YEAR LIMITED WARRANTY

Automatic Equipment Manufacturing Company ("Automatic") warrants to the original (first) retail purchaser that this product, manufactured by Automatic, shall be free from defect in material and workmanship under normal use and service for a period of three years from the date of delivery.

During said three-year period, Automatic will repair or replace any parts that have been returned by the original purchaser, to the factory, transportation prepaid, and in Automatic's sole and absolute opinion found to be defective.

## Limitations on Warranty Coverage:

Coverage under this warranty will be valid only if the customer warranty card is returned by the original purchaser within 30 days of purchase.

Coverage under this warranty will be effective only when a copy of the original invoice, showing date and place of purchase, accompanies any claim for warranty. This warranty is NON TRANSFERABLE.

This limited warranty will not cover, in any way or form, any alleged damages caused by incorrect or improper installation, improper use, modification or neglect of product, failure to properly service and maintain, misuse, act of God, accident or failure of the user to follow guidelines contained in the instructional material provided by Automatic.

This warranty does not cover normal wear and tear, paint or rust.

Warrantor assumes no responsibility to the owner for loss of use of product, loss of time, inconvenience or any other damage consequential or otherwise. Including, but not limited to mileage, expense of transporting of product, return shipping expense, mechanics travel time, telephone, road service, towing, and rental during repairs, travel, lodging, loss or damage to personal property or loss of earnings.

**REPAIR OR REPLACEMENT AS SET FORTH IN THIS LIMITED WARRANTY IS THE SOLE EXCLUSIVE REMEDY OF THE PURCHASER. AUTOMATIC SHALL NOT BE LIABLE FOR ANY INCIDENTAL OR CONSEQUENTIAL DAMAGES FOR BREACH OF ANY EXPRESS OR IMPLIED WARRANTY ON THIS PRODUCT. EXCEPT TO THE EXTENT PROHIBITED BY APPLICABLE LAW, ANY IMPLIED WARRANTY OF MERCHANTABILITY OR FITNESS FOR A PARTICULAR PURPOSE ON THIS PRODUCT IS LIMITED IN LENGTH TO THE DURATION OF THIS WARRANTY.**

Please visit <http://blueox.com/warranty/> to register your warranty

